

RACE	BASIC SET-UP	
TRACK	ASTRO DRY	
NAME	XRAY FACTORY	DATE
LAPS		BEST LAP TIME
QUALIFYING POSITION		FINAL POSITION
<b>TRACK</b>		
SIZE	<input type="checkbox"/> OPEN	<input type="checkbox"/> MEDIUM
TRACTION	<input type="checkbox"/> VERY-LOW <input type="checkbox"/> MEDIUM <input type="checkbox"/> VERY-HIGH	
SURFACE	<input type="checkbox"/> SMOOTH	<input type="checkbox"/> MEDIUM
TYPE	<input type="checkbox"/> CLAY	<input checked="" type="checkbox"/> ASTRO
CONDITION	<input type="checkbox"/> BLUE GROOVE	<input checked="" type="checkbox"/> DRY
	<input type="checkbox"/> DUSTY	<input type="checkbox"/> LOAMY

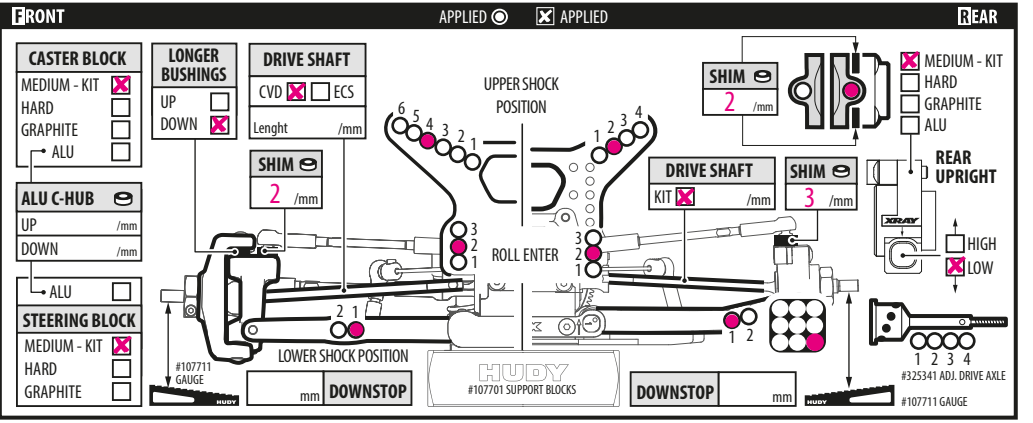

<b>DIFFERENTIAL TYPE</b>		
<b>FRONT</b> ↓	<b>MIDDLE</b> ↓	<b>REAR</b> ↓
GEAR DIFF <input checked="" type="checkbox"/> ACTIVE DIFF <input type="checkbox"/>	SLIPPER <input checked="" type="checkbox"/> GEAR DIFF <input type="checkbox"/> ACTIVE DIFF <input type="checkbox"/>	GEAR DIFF <input checked="" type="checkbox"/> ACTIVE DIFF <input type="checkbox"/>
60° 90° 120°	60° 90° 120°	60° 90° 120°
OIL 10K cst	OIL cst	OIL 10K cst
<b>SATELLITE GEARS</b>		
COMPOSITE <input type="checkbox"/> STEEL <input checked="" type="checkbox"/>	COMPOSITE <input type="checkbox"/> STEEL <input type="checkbox"/>	COMPOSITE <input type="checkbox"/> STEEL <input checked="" type="checkbox"/>
40T <input checked="" type="checkbox"/> 41T <input type="checkbox"/>	CROWN GEAR	40T <input checked="" type="checkbox"/> 41T <input type="checkbox"/>

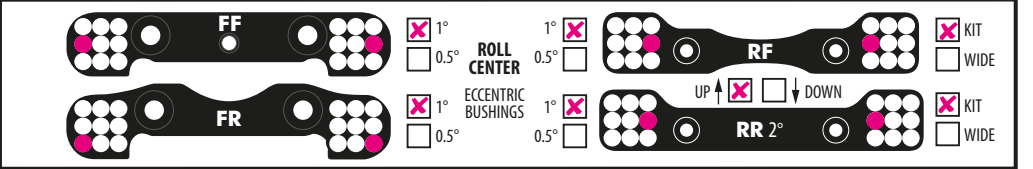
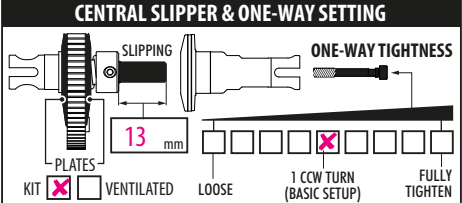
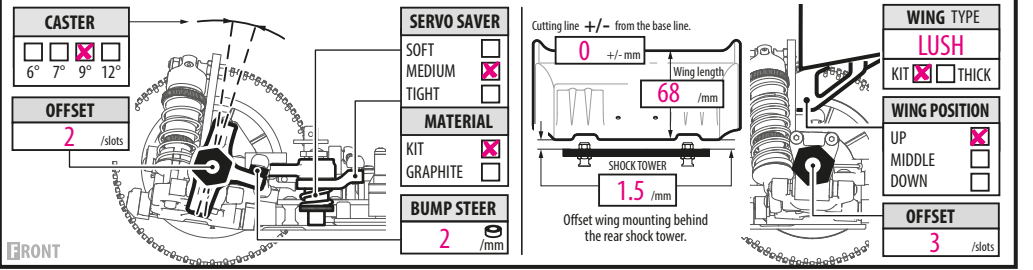

<b>GEARING</b>	
PINION	81
SPUR GEAR	

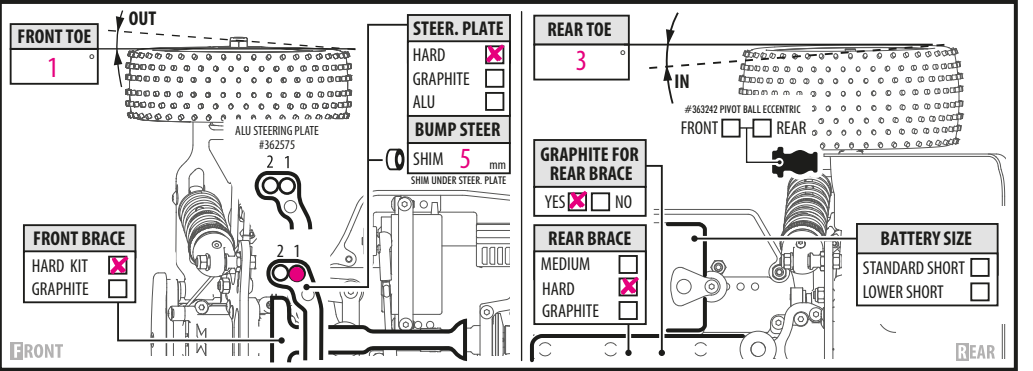

<b>FRONT</b>	<b>SHOCKS</b>	<b>REAR</b>
3 DOTS	SPRINGS	3 DOTS
cst 400	OIL	cst 300
% 0	REBOUND	% 0
2 HOLES <input checked="" type="checkbox"/>	<input checked="" type="checkbox"/> ø1.6mm	2 HOLES <input checked="" type="checkbox"/>
<input type="checkbox"/> ø1.8mm	<input checked="" type="checkbox"/> ø2.0mm	<input type="checkbox"/> ø2.5mm
PISTON THICKNESS	<input checked="" type="checkbox"/> 2.0mm	<input type="checkbox"/> 2.5mm
<input type="checkbox"/> 0mm	<input checked="" type="checkbox"/> 0mm	<input type="checkbox"/> 2mm
<input type="checkbox"/> -2mm	<input checked="" type="checkbox"/> -2mm	<input type="checkbox"/> -4mm
<input type="checkbox"/> -4mm	<input checked="" type="checkbox"/> KIT	<input type="checkbox"/> ALU
<input type="checkbox"/> +4mm	<input checked="" type="checkbox"/> BALL JOINT	<input type="checkbox"/> +2mm
<input type="checkbox"/> +2mm	<input checked="" type="checkbox"/> KIT	<input type="checkbox"/> +4mm

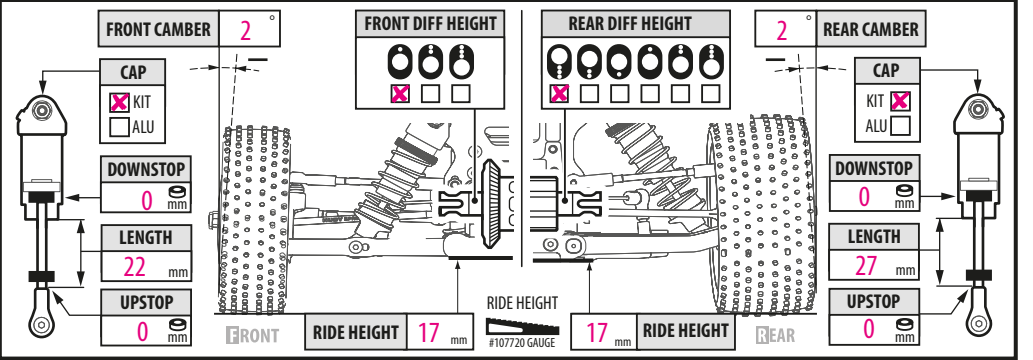

<b>FRONT</b>	<b>ANTI ROLL BAR</b>	<b>REAR</b>
1.8 mm	THICKNESS	1.8 mm

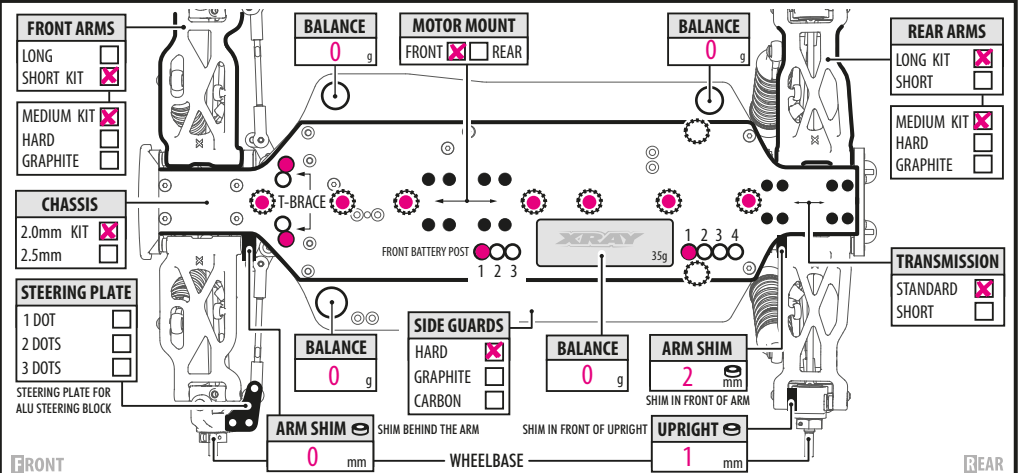

<b>FRONT</b>	<b>TIRES</b>	<b>REAR</b>
	BRAND	
	COMPOUND	
	INSERTS	
XRAY	WHEELS	XRAY

<b>ELECTRONICS</b>	
MOTOR	SPEEDO
MOTOR TIMING	BATTERY

<b>BODY</b>	<b>TOTAL WEIGHT</b>
XRAY GAMMA 4C <input type="checkbox"/> LIGHT <input type="checkbox"/>	/g

**COMMENTS**