

1/10 ELECTRIC OFF-ROAD BUGGY 4WD

XTRAY XB4

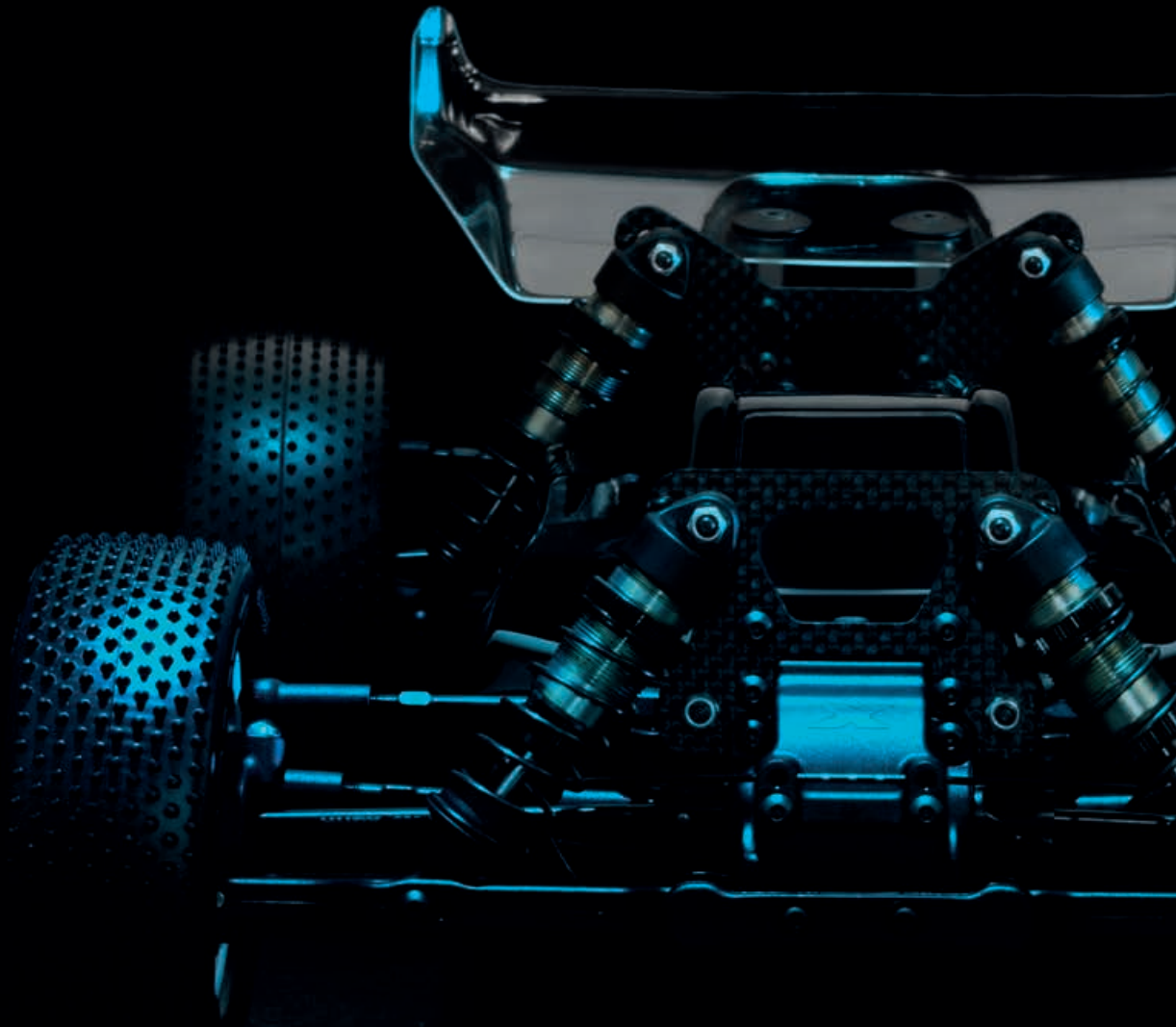

INSTRUCTION MANUAL
FOR XB4C'25 & XB4D'25 EDITION

BEFORE YOU START

This is a high-competition, high-quality RC car intended for persons aged 16 years and older with previous experience building and operating RC model racing cars. This is NOT a toy; it is a precision racing model. This model racing car is NOT intended for use by beginners, inexperienced customers, or by children without direct supervision of a responsible, knowledgeable adult. If you DO NOT fulfill these requirements, please return the kit in unused and unassembled form back to the shop where you have purchased it.

Before building and operating your XRAY, **YOU MUST** read through all of the operating instructions and instruction manual and fully understand them to get the maximum enjoyment and prevent unnecessary damage.

CUSTOMER SUPPORT

We have made every effort to make these instructions as easy to understand as possible. However, if you have any difficulties, problems, or questions, please DO NOT hesitate to contact the XRAY support team at info@teamxray.com. Also, please visit our Web site at www.teamxray.com to find the latest updates, set-up information, option parts, and many other goodies. We pride ourselves on taking excellent care of our customers.

You can join thousands of XRAY fans and enthusiasts in our online community at: www.teamxray.com

Read carefully and fully understand the instructions before beginning assembly.

Make sure you review this entire manual, download and use set-up book from the web, and examine all details carefully. If for some reason you decide this is NOT what you wanted or expected, **DO NOT continue any further**. Your hobby dealer can NOT accept your kit for return or exchange after it has been partially or fully assembled.

Contents of the box may differ from pictures. In line with our policy of continuous product development, the exact specifications of the kit may vary without prior notice.

XRAY Europe

K Vystavisku 6992
91101 Trenčín
Slovakia, EUROPE
Phone: 421-32-7401100
Fax: 421-32-7401109
E-mail: info@teamxray.com

XRAY USA

RC America, 2030 Century Center Blvd #15 Irving,
TX 75062
USA
Phone: (214) 744-2400
Fax: (214) 744-2401
E-mail: xray@rcamerica.com

FAILURE TO FOLLOW THESE INSTRUCTIONS WILL BE CONSIDERED AS ABUSE AND/OR NEGLIGENCE.

SAFETY PRECAUTIONS

Contains:

LEAD (CAS 7439-92-1) ANTIMONY (CAS 7440-36-0)

WARNING: This product contains a chemical known to the state of California to cause cancer and birth defects or other reproductive harm.

CAUTION: CANCER HAZARD

Contains lead, a listed carcinogen. Lead is harmful if ingested. Wash thoroughly after using. DO NOT use product while eating, drinking or using tobacco products. May cause chronic effects to gastrointestinal tract, CNS, kidneys, and blood. **MAY CAUSE BIRTH DEFECTS.**

When building, using and/or operating this model always wear protective glasses and gloves.

Take appropriate safety precautions prior to operating this model. You are responsible for this model's assembly and safe operation! Please read the instruction manual before building and operating this model and follow all safety precautions. Always keep the instruction manual at hand for quick reference, even after completing the assembly. Use only genuine and original

authentic XRAY parts for maximum performance. Using any third party parts on this model will void warranty immediately.

Improper operation may cause personal and/or property damage. XRAY and its distributors have no control over damage resulting from shipping, improper construction, or improper usage. XRAY assumes and accepts no responsibility for personal and/or property damages resulting from the use of improper building materials, equipment and operations. By purchasing any item produced by XRAY, the buyer expressly warrants that he/she is in compliance with all applicable federal, state and local laws and regulation regarding the purchase, ownership and use of the item. The buyer expressly agrees to indemnify and hold harmless XRAY for all claims resulting directly or indirectly from the purchase, ownership or use of the product. By the act of assembling or operating this product, the user accepts all resulting liability. If the buyer is NOT prepared to accept this liability, then he/she should return this kit in new, unassembled, and unused condition to the place of purchase.



IMPORTANT NOTES – GENERAL

- This product is NOT suitable for children under 16 years of age without the direct supervision of a responsible and knowledgeable adult.
 - Carefully read all manufacturers warnings and cautions for any parts used in the construction and use of your model.
 - Assemble this kit only in places away from the reach of very small children.
 - First-time builders and users should seek advice from people who have building experience in order to assemble the model correctly and to allow the model to reach its performance potential.
 - Exercise care when using tools and sharp instruments.
 - Take care when building, as some parts may have sharp edges.
 - Keep small parts out of reach of small children. Children must NOT be allowed to put any parts in their mouth, or pull vinyl bag over their head.
 - Read and follow instructions supplied with paints and/or cement, if used (NOT included in kit).
 - Immediately after using your model, DO NOT touch equipment on the model such as the motor and speed controller, because they generate high temperatures. You may seriously burn yourself seriously touching them.
 - Follow the operating instructions for the radio equipment at all times.
 - DO NOT put fingers or any objects inside rotating and moving parts, as this may cause damage or serious injury as your finger, hair, clothes, etc. may get caught.
 - Be sure that your operating frequency is clear before turning on or running your model, and never share the same frequency with somebody else at the same time. Ensure that others are aware of the operating frequency you are using and when you are using it.
 - Use a transmitter designed for ground use with RC cars. Make sure that no one else is using the same frequency as yours in your operating area. Using the same frequency at the same time, whether it is driving, flying or sailing, can cause loss of control of the RC model, resulting in a serious accident.
 - Always turn on your transmitter before you turn on the receiver in the car. Always turn off the receiver before turning your transmitter off.
 - Keep the wheels of the model off the ground when checking the operation of the radio equipment.
 - Disconnect the battery pack before storing your model.
 - When learning to operate your model, go to an area that has no obstacles that can damage your model if your model suffers a collision.
 - Remove any sand, mud, dirt, grass or water before putting your model away.
 - If the model behaves strangely, immediately stop the model, check and clear the problem.
 - To prevent any serious personal injury and/or damage to property, be responsible when operating all remote controlled models.
 - The model car is NOT intended for use on public places and roads or areas where its operation can conflict with or disrupt pedestrian or vehicular traffic.
 - Because the model car is controlled by radio, it is subject to radio interference from many sources that are beyond your control. Since radio interference can cause momentary loss of control, always allow a safety margin in all directions around the model in order to prevent collisions.
 - DO NOT use your model:
 - Near real cars, animals, or people that are unaware that an RC car is being driven.
 - In places where children and people gather
 - In residential districts and parks
 - In limited indoor spaces
 - In wet conditions
 - In the street
 - In areas where loud noises can disturb others, such as hospitals and residential areas.
 - At night or anytime your line of sight to the model may be obstructed or impaired in any way.
- To prevent any serious personal injury and/or damage to property, please be responsible when operating all remote controlled models.

IMPORTANT NOTES – ELECTRICAL

- Insulate any exposed electrical wiring (using heat shrink tubing or electrical tape) to prevent dangerous short circuits. Take maximum care in wiring, connecting and insulating cables. Make sure cables are always connected securely. Check connectors for if they become loose. And if so, reconnect them securely. Never use RC models with damaged wires. A damaged wire is extremely dangerous, and can cause short-circuits resulting in fire. Please have wires repaired at your local hobby shop.
- Low battery power will result in loss of control. Loss of control can occur due to a weak battery in either the transmitter or the receiver. Weak running battery may also result in an out of control car if your car's receiver power is supplied by the running battery. Stop operation immediately if the car starts to slow down.
- When NOT using RC model, always disconnect and remove battery.
- DO NOT disassemble battery or cut battery cables. If the running battery short-circuits, approximately 300W of electricity can be discharged, leading to fire or burns. Never disassemble battery or cut battery cables.
- Use a recommended charger for the receiver and transmitter batteries and follow the instructions correctly. Over-charging, incorrect charging, or using inferior chargers can

cause the batteries to become dangerously hot. Recharge battery when necessary. Continual recharging may damage battery and, in the worst case, could build up heat leading to fire. If battery becomes extremely hot during recharging, please ask your local hobby shop for check and/or repair and/or replacement.

- Regularly check the charger for potential hazards such as damage to the cable, plug, casing or other defects. Ensure that any damage is rectified before using the charger again. Modifying the charger may cause short-circuit or overcharging leading to a serious accident. Therefore DO NOT modify the charger.
- Always unplug charger when recharging is finished.
- DO NOT recharge battery while battery is still warm. After use, battery retains heat. Wait until it cools down before charging.
- DO NOT allow any metal part to short circuit the receiver batteries or other electrical/electronic device on the model.
- Immediately stop running if your RC model gets wet as may cause short circuit.
- Please dispose of batteries responsibly. Never put batteries into fire.

R/C & BUILDING TIPS

- Make sure all fasteners are properly tightened. Check them periodically.
- Make sure that chassis screws DO NOT protrude from the chassis.
- For the best performance, it is very important that great care is taken to ensure the free movement of all parts.
- Clean all ball-bearings so they move very easily and freely.
- Tap or pre-thread the plastic parts when threading screws.
- Self-tapping screws cut threads into the parts when being tightened. DO NOT use excessive force when tightening the self-tapping screws because you may strip out the thread in the plastic. We recommended you stop tightening a screw when you feel some resistance.

- Ask your local hobby shop for any advice.

Please support your local hobby shop. We at XRAY Model Racing Cars support all local hobby dealers. Therefore we ask you, if at all possible, to purchase XRAY products at your hobby dealer and give them your support like we do.

If you have difficulty finding XRAY products, please check out www.teamxray.com to get advice, or contact us via email at info@teamxray.com, or contact the XRAY distributor in your country.

WARRANTY

XRAY guarantees this model kit to be free from defects in both material and workmanship within 30 days of purchase. The total monetary value under warranty will in no case exceed the cost of the original kit purchased. This warranty DOES NOT cover any components damaged by use or modification or as a result of wear. Part or parts missing from this kit must be reported within 30 days of purchase. No part or parts will be sent under warranty without proof of purchase. Should you find a defective or missing part, contact the local distributor. Service and customer support will be provided through local hobby store where you have purchased the kit, therefore make sure to purchase any XRAY products at your local hobby store. This model racing car is considered to be a high-performance racing vehicle. As such this vehicle will be used in an extreme range of conditions and situations, all which may cause premature wear or failure of any component. XRAY has no control over usage of vehicles once they leave the dealer, therefore XRAY can only offer warranty against all manufacturer's defects in materials, workmanship, and assembly at point of sale and before use. No warranties are expressed or implied that cover damage caused by what is considered normal use, or cover or imply how long any model cars' components or electronic components will last before requiring replacement.

Due to the high performance level of this model car you will need to periodically maintain and replace consumable components. Any and all warranty coverage will NOT cover replacement of any part or component damaged by neglect, abuse, or improper or unreasonable use. This includes but is NOT limited to damage from crashing, chemical and/or water damage, excessive moisture, improper or no maintenance, or user modifications which compromise the

integrity of components. Warranty will NOT cover components that are considered consumable on RC vehicles. XRAY DOES NOT pay nor refund shipping on any component sent to XRAY or its distributors for warranty. XRAY reserves the right to make the final determination of the warranty status of any component or part.

LIMITATIONS OF LIABILITY.

XRAY makes no other warranties expressed or implied. XRAY shall NOT be liable for any loss, injury or damages, whether direct, indirect, special, incidental, or consequential, arising from the use, misuse, or abuse of this product and/or any product or accessory required to operate this product. In no case shall XRAY's liability exceed the monetary value of this product.

Take adequate safety precautions prior to operating this model. You are responsible for this model's assembly and safe operation.

Disregard of the any of the above cautions may lead to accidents, personal injury, or property damage.

XRAY MODEL RACING CARS assumes no responsibility for any injury, damage, or misuse of this product during assembly or operation, nor any addictions that may arise from the use of this product.

All rights reserved.

QUALITY CERTIFICATE

XRAY MODEL RACING CARS uses only the highest quality materials, the best compounds for molded parts and the most sophisticated manufacturing processes of TQM (Total Quality Management). We guarantee that all parts of a newly-purchased kit are manufactured with the highest regard to quality. However, due to the many factors inherent in model racecar

competition, we cannot guarantee any parts once you start racing the car. Products which have been worn out, abused, neglected or improperly operated will NOT be covered under warranty. We wish you enjoyment of this high-quality and high-performance RC car and wish you best success on the track!

In line with our policy of continuous product development, the exact specifications of the kit may vary. In the unlikely event of any problems with your new kit, you should contact the model shop where you purchased it, quoting the part number.

We do reserve all rights to change any specification without prior notice. All rights reserved.

TOOLS REQUIRED

 **OPTION**

Combination Pliers
(HUDY #189020)

Side Cutters
(HUDY #189010)

Pocket Hobby Knife (HUDY #188981)

Special Tool for turnbuckles, nuts (HUDY #181090)

Turnbuckle Wrench 3mm (HUDY #181030)

Turnbuckle Wrench 3.5mm (HUDY #181035)

HUDY Tweezers Straight (HUDY #188970)

HUDY Tweezers Curved (HUDY #188971)

Allen 1.5mm (#111545 - HUDY EXCLUSIVE Limited Edition)

Allen 2.0mm (#112045 - HUDY EXCLUSIVE Limited Edition)

Arm Reamer 3.0mm (#107643 - HUDY EXCLUSIVE Limited Edition)

Socket 5.5mm (#175535 - HUDY EXCLUSIVE Limited Edition)















Socket 7.0mm (#177035 - HUDY EXCLUSIVE Limited Edition)

Reamer (#107602 - HUDY EXCLUSIVE Limited Edition)

Scissors (HUDY #188990)

Professional Multi Tool
(HUDY #183011)

EQUIPMENT INCLUDED

<p>300cSt (#106330) HUDY Premium Silicone Oils</p>  <p>300cSt</p> <p> SILICONE OIL</p> <p>CARPET DIRT</p>	<p>350cSt (#106335) HUDY Premium Silicone Oils</p>  <p>350cSt</p> <p> SILICONE OIL</p> <p>CARPET DIRT</p>	<p>30.000cSt (#106530) HUDY Premium Silicone Oils</p>  <p>30.000cSt</p> <p> SILICONE OIL</p> <p>CARPET</p>	<p>40.000cSt (#106540) HUDY Premium Silicone Oils</p>  <p>40.000cSt</p> <p> SILICONE OIL</p> <p>CARPET</p>	<p>10.000cSt (#106510) HUDY Premium Silicone Oils</p>  <p>10.000cSt</p> <p> SILICONE OIL</p> <p>DIRT</p>	<p>100.000cSt (#106610) HUDY Premium Silicone Oils</p>  <p>100K cSt</p> <p> SILICONE OIL</p> <p>DIRT</p>	<p>(HUDY #106210) Premium Graphite Grease</p>  <p> GRAPHITE GREASE</p> <p>CARPET DIRT</p>
--	--	---	---	--	---	---

EQUIPMENT REQUIRED

<p>Transmitter</p> 	<p>Receiver</p> 	<p>Speed Controller</p> 	<p>Steering Servo</p> 	<p>Electric Motor & Pinion Gear with Setscrew</p> 	<p>LiPo Battery</p> 	
<p>Battery Charger</p> 	<p> OPTION</p> <p>Double-sided Tape (HUDY #107875)</p> 	<p>Lexan™ Paint</p> 	<p>4x Tires & Inserts</p> 	<p> OPTION</p> <p>Bearing Oil (HUDY #106230)</p> 	<p>Threadlock</p> 	<p>CA glue</p> 

COLOR INDICATIONS

At the beginning of each section is an exploded view of the parts to be assembled. There is also a list of all the parts and part numbers that are related to the assembly of that section.

The part descriptions are color-coded to make it easier for you to identify the source of a part. Here are what the different colors mean:

- 361202
- 361115
- 364903
- 365100

STYLE A - indicates parts for both kit versions that are included in the bag marked for the section.

STYLE B - indicates parts that are included in the box.

STYLE C - indicates parts that are already assembled from previous steps.

STYLE D - indicates parts that are optional. (NOT INCLUDED)

STYLE E - indicates Dirt Edition only

STYLE F - indicates Carpet Edition only

TECH TIPS

TIP DRIVE SHAFT PIN SERVICING

To enjoy the longest possible lifespan of the drive shafts and diff outrdrives, it is extremely important to properly service the drive shaft pins. Inspect the pins after every 3 hours of runtime. If the pins show any wear, replace them with new pins.



DO NOT use drive shafts when the pins are worn.

Press out the worn pins.

Press in new pins and regularly inspect for wear.



For quick & easy drive pin replacements use #106000 HUDY Drive Pin Replacement Tool together with #106036 Ejector Pivot Pin & Alternating Pivot 2.5mm.

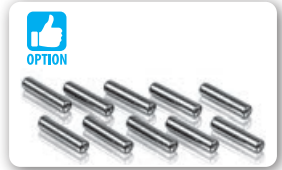

To replace the worn pins use only premium HUDY drive pins (#106053 2.5mm dia x 10mm length)

TIP CARBON PARTS PREPARATION

Follow this Tech Tip to prepare the carbon parts. Sand the edges with sandpaper, and then seal the edges with CA glue to reinforce them and help prevent delamination.

Prepare all Carbon Parts:

- Front shock tower
- Rear shock tower

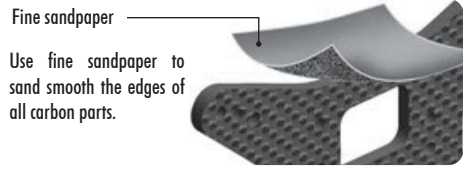

Fine sandpaper
Use fine sandpaper to sand smooth the edges of all carbon parts.



Apply CA glue to all edges of the carbon parts.



TIP

All ball-bearings are factory pre-oiled or pre-greased. The bearings of each type are packaged separately; there is a BAG 00.9 with pre-greased ball-bearings and a separate bag with pre-oiled ball-bearings.

For pre-oiled ball-bearings, use:
#106230 HUDY Bearing Oil.

For pre-greased ball-bearings with rubber covers, use one of these bearing greases:
#106220 - HUDY Bearing Grease - suggested for extremely dusty track conditions.
#106221 - HUDY Bearing Grease "Blue" - suggested for medium dusty track conditions.
#106222 - HUDY Bearing Grease "Red" - suggested for low dusty track conditions.

Replace any bearings that develop a "gritty" feeling to prevent inefficiency and avoid failures.

Make sure to use only original XRAY ball-bearings, which all have specific tolerances, axial and radial play, and are all individually selected. Using 3rd party ball-bearings may result in bearing failures and damage to other parts.

MANUAL STEPS ONLY FOR DIRT

1. BALL DIFFERENTIAL DIRT

BAG 01

MANUAL STEPS ONLY FOR CARPET

1. GEAR DIFFERENTIAL CARPET

BAG 02

MANUAL DUAL STEPS FOR CARPET AND DIRT

3. REAR DRIVETRAIN CARPET DIRT

OPTION PARTS

HUDY PREMIUM SILICONE OILS

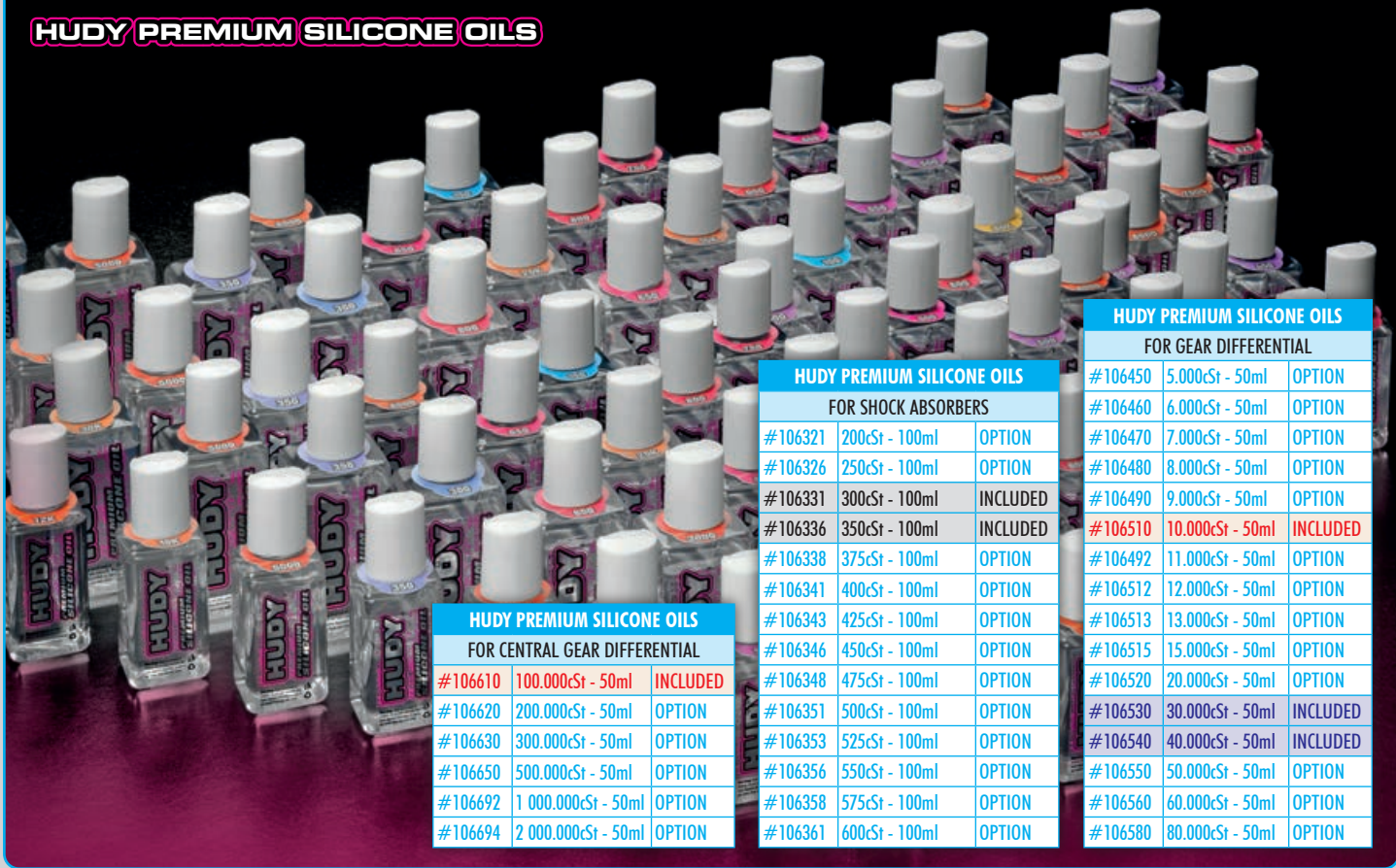

HUDY PREMIUM SILICONE OILS FOR CENTRAL GEAR DIFFERENTIAL			HUDY PREMIUM SILICONE OILS FOR SHOCK ABSORBERS			HUDY PREMIUM SILICONE OILS FOR GEAR DIFFERENTIAL		
#106610	100.000cSt - 50ml	INCLUDED	#106321	200cSt - 100ml	OPTION	#106450	5.000cSt - 50ml	OPTION
#106620	200.000cSt - 50ml	OPTION	#106326	250cSt - 100ml	OPTION	#106460	6.000cSt - 50ml	OPTION
#106630	300.000cSt - 50ml	OPTION	#106331	300cSt - 100ml	INCLUDED	#106470	7.000cSt - 50ml	OPTION
#106650	500.000cSt - 50ml	OPTION	#106336	350cSt - 100ml	INCLUDED	#106480	8.000cSt - 50ml	OPTION
#106692	1 000.000cSt - 50ml	OPTION	#106338	375cSt - 100ml	OPTION	#106490	9.000cSt - 50ml	OPTION
#106694	2 000.000cSt - 50ml	OPTION	#106341	400cSt - 100ml	OPTION	#106510	10.000cSt - 50ml	INCLUDED
			#106343	425cSt - 100ml	OPTION	#106492	11.000cSt - 50ml	OPTION
			#106346	450cSt - 100ml	OPTION	#106512	12.000cSt - 50ml	OPTION
			#106348	475cSt - 100ml	OPTION	#106513	13.000cSt - 50ml	OPTION
			#106351	500cSt - 100ml	OPTION	#106515	15.000cSt - 50ml	OPTION
			#106353	525cSt - 100ml	OPTION	#106520	20.000cSt - 50ml	OPTION
			#106356	550cSt - 100ml	OPTION	#106530	30.000cSt - 50ml	INCLUDED
			#106358	575cSt - 100ml	OPTION	#106540	40.000cSt - 50ml	INCLUDED
			#106361	600cSt - 100ml	OPTION	#106550	50.000cSt - 50ml	OPTION
						#106560	60.000cSt - 50ml	OPTION
						#106580	80.000cSt - 50ml	OPTION

HUDY TITANIUM 5.4mm BALL STUDS

Ø 5.4mm



HUDY TITANIUM 4.9mm BALL STUDS

Ø 4.9mm



**TITANIUM MATERIAL SUPER LIGHTWEIGHT ULTRA-PRECISE
LONG LIFE HIGH DURABILITY MADE BY HUDY
MADE IN EUROPE**

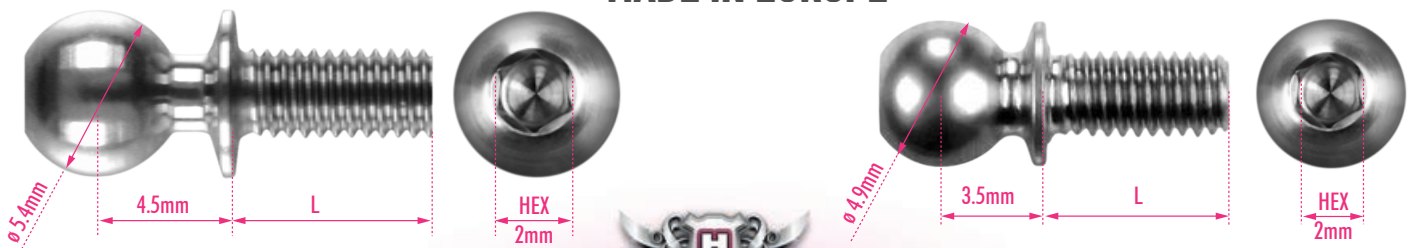

1. FRONT & REAR DIFFERENTIAL

CARPET DIRT

#364941
 STEEL DIFFERENTIAL BEVEL GEAR FOR LARGE VOLUME DIFF 41T
 OPTION



#335080
 STEEL DIFFERENTIAL PIN HARDCOATED (2)
 OPTION

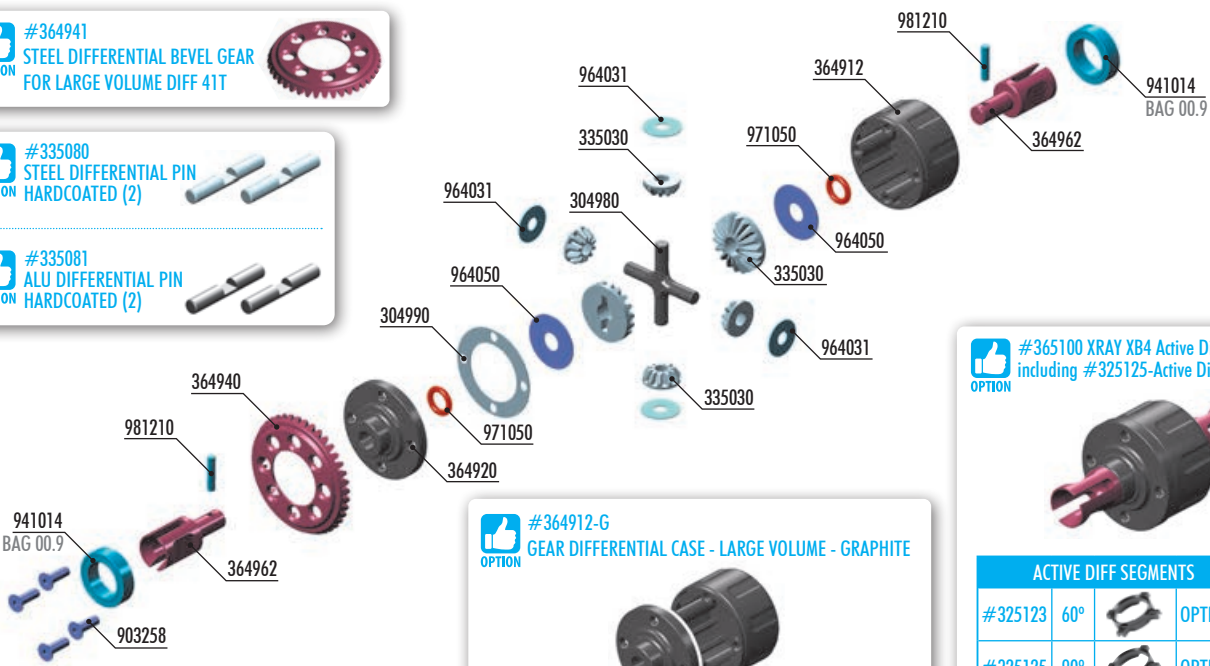

#335081
 ALU DIFFERENTIAL PIN HARDCOATED (2)
 OPTION

#364912-G
 GEAR DIFFERENTIAL CASE - LARGE VOLUME - GRAPHITE
 OPTION





#364920-G
 GEAR DIFFERENTIAL COVER - LARGE VOLUME - GRAPHITE
 OPTION



#365100 XRAY XB4 Active Diff Front/Rear -Set
 including #325125-Active Diff Segment 90°
 OPTION



ACTIVE DIFF SEGMENTS			
#325123	60°		OPTION
#325125	90°		OPTION
#325127	120°		OPTION

BAG
01
2x
 Gear Differentials

- 304980 COMPOSITE GEAR DIFF CROSS PIN
- 304990 DIFF GASKET (4)
- 335030 STEEL DIFF BEVEL & SATELLITE GEARS (2+4)
- 364903 GEAR DIFFERENTIAL - LARGE VOLUME - SET
- 364912 COMPOSITE GEAR DIFFERENTIAL CASE - LARGE VOLUME
- 364920 COMPOSITE GEAR DIFFERENTIAL COVER - LARGE VOLUME
- 364940 STEEL DIFFERENTIAL BEVEL GEAR FOR LARGE VOLUME DIFF 40T
- 364962 GEAR DIFF OUTDRIVE ADAPTER FOR LARGE VOLUME DIFF (2)

- 903258 HEX SCREW SFH M2.5x8 (10)
- 941014 BALL-BEARING 10x15x4 RUBBER SEALED - GREASE (8)
- 964031 WASHER S 3.5x10x0.2 (10)
- 964050 WASHER S 5x15x0.3 (10)
- 971050 SILICONE O-RING 5x1.5 (10)
- 981210 PIN 2x10 (10)

2x

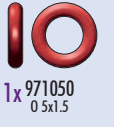
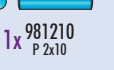
-  1x 964050 S 5x15x0.3
-  1x 971050 O 5x1.5
-  1x 981210 P 2x10

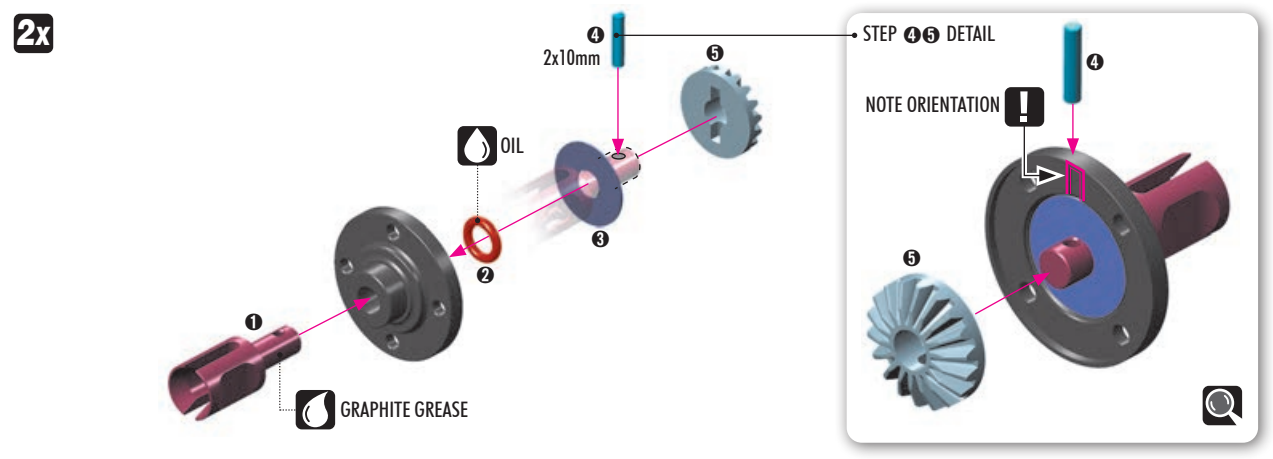

2x

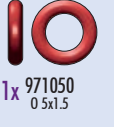
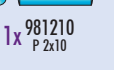
-  1x 964050 S 5x15x0.3
-  1x 971050 O 5x1.5
-  1x 981210 P 2x10

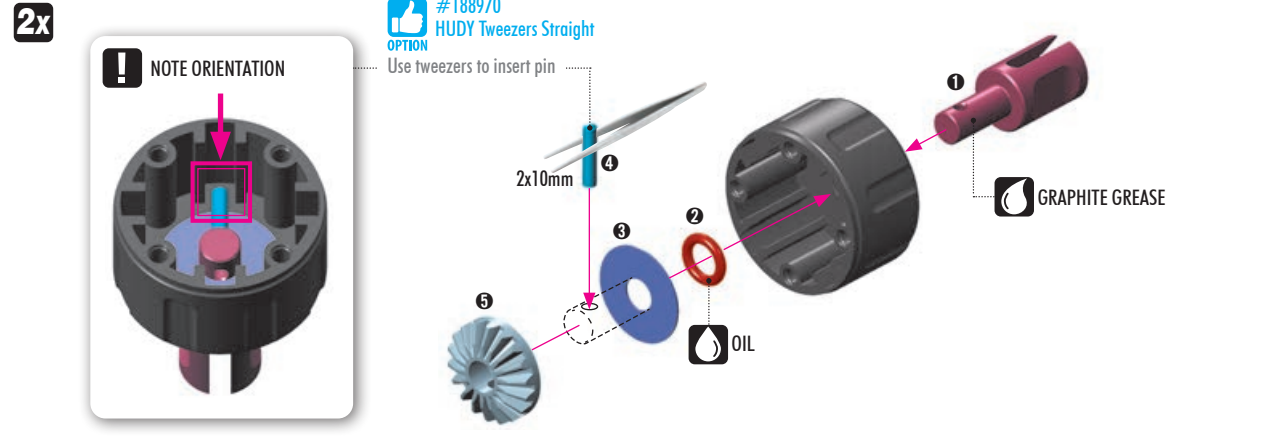

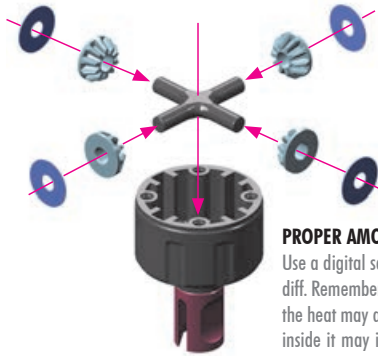

PROPER AMOUNT OF OIL IN THE DIFFS
Use a digital scale to measure the exact amount of oil in the diff. Remember that during operation the diff gets hotter and the heat may allow the oil to expand. If there is too much oil inside it may interfere with the diff operation and damage the internal gears.

Front diff Silicone oil
CARPET 40.000cSt
DIRT 10.000cSt
 Fill just above the cross-pins.

Rear diff Silicone oil
CARPET 30.000cSt
DIRT 10.000cSt
 Fill just above the cross-pins.

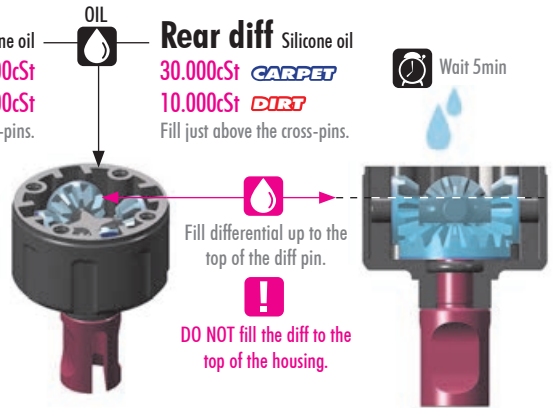

TO ENSURE YOU HAVE THE SAME AMOUNT OF OIL FROM REBUILD TO REBUILD, DO THE FOLLOWING:

1 Put the diff (without oil) on the scale and check the weight.

2 Slowly pour oil into the diff and watch the weight. Add 1.80g of oil into the diff.

$16.97g + 1.80g = 18.77g$

#107865 HUDY Professional Digital Pocket Scale 300g/0.01g
 #107866 HUDY Professional Digital Pocket Scale 3000g/0.1g

TIP	FRONT DIFFERENTIAL	TIPS FOR DIFFERENTIALS	REAR DIFFERENTIAL	TIP
DIRT	LOW TRACTION 7.000cSt (HUDY #106470) MEDIUM TRACTION 10.000cSt (HUDY #106510) HIGH TRACTION 15.000cSt (HUDY #106515)	<p>! Softer oil increases steering, harder oil increases stability.</p> <p>! Softer oil increases rear traction, harder oil increases on-power steering.</p>	DIRT LOW TRACTION 7.000cSt (HUDY #106470) MEDIUM TRACTION 10.000cSt (HUDY #106510) HIGH TRACTION 15.000cSt (HUDY #106515)	
CARPET	LOW TRACTION 30.000cSt (HUDY #106530) MEDIUM TRACTION 40.000cSt (HUDY #106540) HIGH TRACTION 50.000cSt (HUDY #106550)		CARPET LOW TRACTION 20.000cSt (HUDY #106520) MEDIUM TRACTION 30.000cSt (HUDY #106530) HIGH TRACTION 40.000cSt (HUDY #106540)	

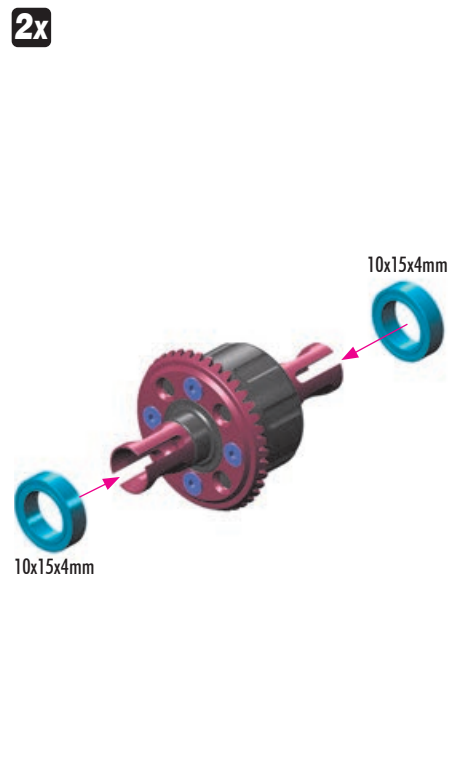
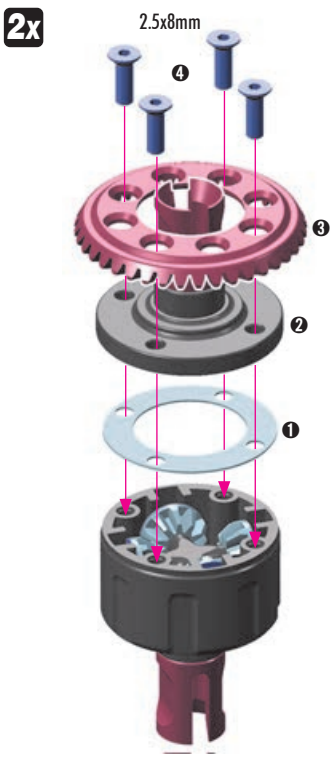
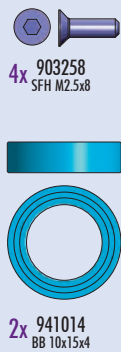

2. CENTER GEAR DIFFERENTIAL



#365101 XRAY XB4 Active Diff Center -Set including #325125-Active Diff Segment 90°
OPTION



ACTIVE DIFF SEGMENTS			
#325123	60°		OPTION
#325125	90°		OPTION
#325127	120°		OPTION

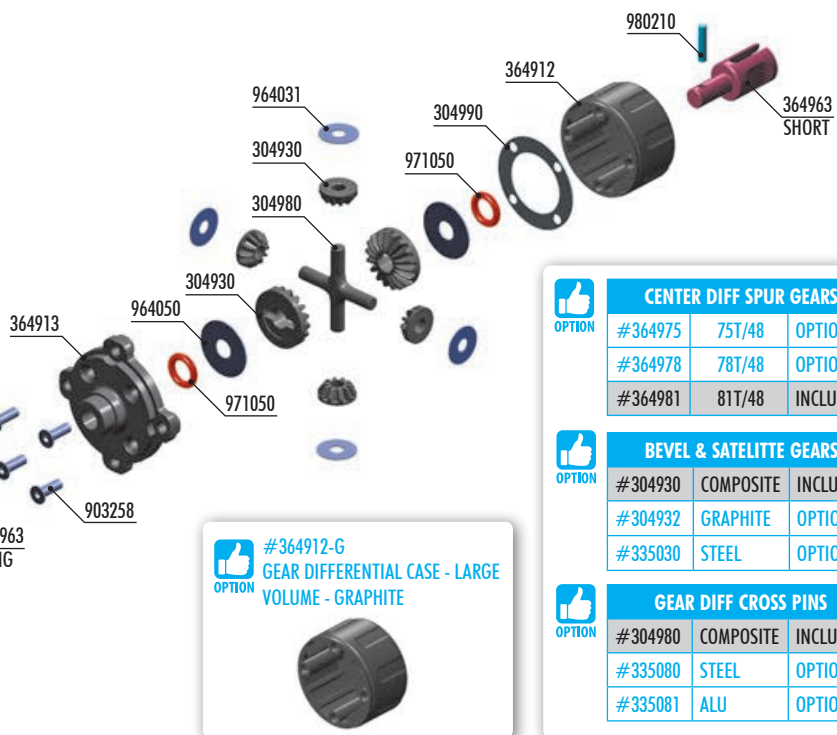

OPTION

CENTER DIFF SPUR GEARS		
#364975	75T/48	OPTION
#364978	78T/48	OPTION
#364981	81T/48	INCLUDED

OPTION

BEVEL & SATELLITE GEARS		
#304930	COMPOSITE	INCLUDED
#304932	GRAPHITE	OPTION
#335030	STEEL	OPTION

OPTION

GEAR DIFF CROSS PINS		
#304980	COMPOSITE	INCLUDED
#335080	STEEL	OPTION
#335081	ALU	OPTION

#364912-G
GEAR DIFFERENTIAL CASE - LARGE VOLUME - GRAPHITE
OPTION

BAG

02

- 304930 COMPOSITE GEAR DIFF BEVEL & SATELLITE GEARS (2+4)
- 304980 COMPOSITE GEAR DIFF CROSS PIN
- 304990 DIFF GASKET (4)
- 364904 GEAR CENTER DIFFERENTIAL - LARGE VOLUME - SET
- 364912 COMPOSITE GEAR DIFFERENTIAL CASE - LARGE VOLUME
- 364913 COMPOSITE CENTER GEAR DIFF ADAPTER - LARGE VOLUME
- 364963 CENTER GEAR DIFF OUTDRIVE ADAPTER FOR LARGE VOLUME DIFF (1+1)
- 364981 COMPOSITE CENTER DIFF SPUR GEAR 81T / 48

- 902306 HEX SCREW SH M3x6 (10)
- 903258 HEX SCREW SFH M2.5x8 (10)
- 964031 WASHER S 3.5x10x0.2 (10)
- 964050 WASHER S 5x15x0.3 (10)
- 971050 SILICONE O-RING 5x1.5 (10)
- 980210 PIN 2x10 (10)



1x 964050
S 5x15x0.3



1x 971050
O 5x1.5



1x 980210
P 2x10

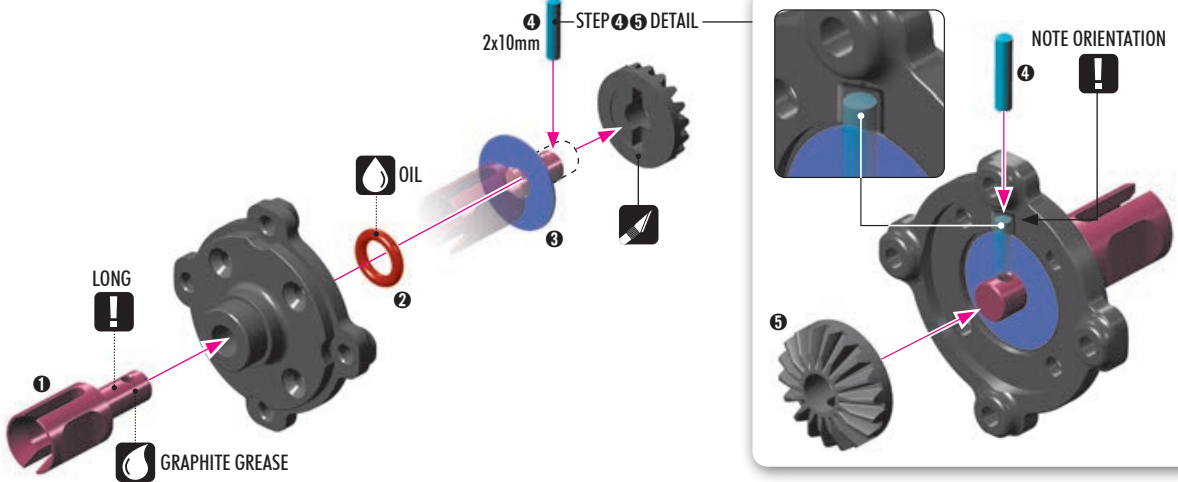

1x 964050
S 5x15x0.3



1x 971050
O 5x1.5



1x 980210
P 2x10

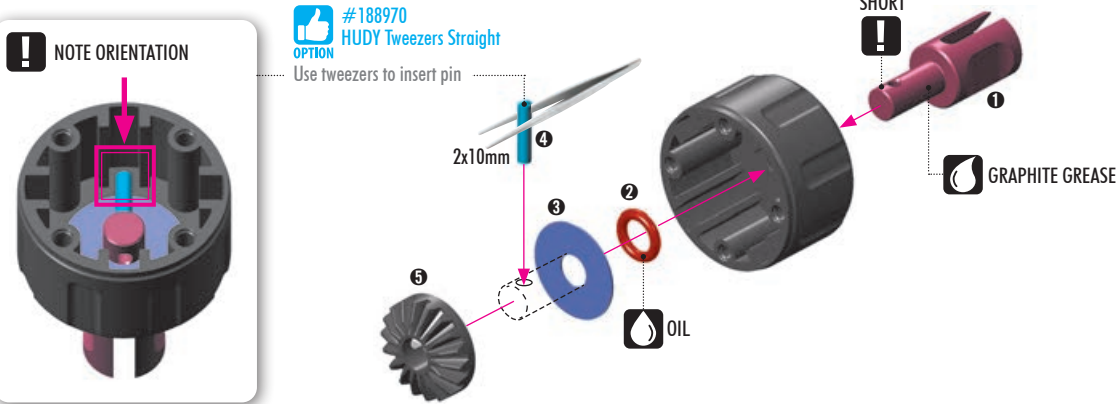

2. CENTER GEAR DIFFERENTIAL

DIRT



1x 964031
S 3.5x10x0.2

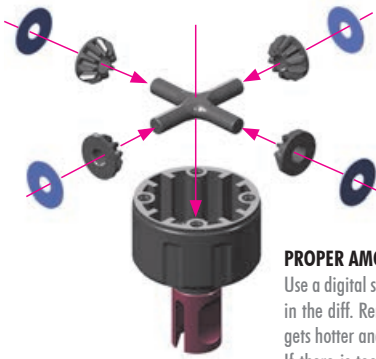

PROPER AMOUNT OF OIL IN THE DIFFS

Use a digital scale to measure the exact amount of oil in the diff. Remember that during operation the diff gets hotter and the heat may allow the oil to expand. If there is too much oil inside it may interfere with the diff operation and damage the internal gears.

Center diff
Silicone oil 100.000cSt
Fill just above the diff pin.

⌚ Wait 5min



Fill differential up to the top of the diff pin.

!
DO NOT fill the diff to the top of the housing.

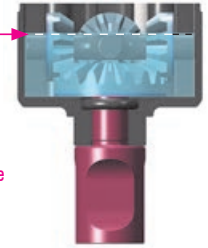

TO ENSURE YOU HAVE THE SAME AMOUNT OF OIL FROM REBUILD TO REBUILD, DO THE FOLLOWING:



1 Put the diff (without oil) on the scale and check the weight (approximately 11.72g)



2 Slowly pour oil into the diff and watch the weight.

CENTER Diff. 11.72g + 1.50g = 13.22g

#107865
HUDY Professional Digital Pocket Scale 300g/0.01g
OPTION

#107866
HUDY Professional Digital Pocket Scale 3000g/0.1g
OPTION

TIP FOR CENTER DIFFERENTIAL

LOW TRACTION 50.000cSt (HUDY #106550)
MEDIUM TRACTION 100.000cSt (HUDY #106610)
HIGH TRACTION 500.000cSt (HUDY #106650)

NOTE:
Softer oil increases steering, harder oil increases stability.

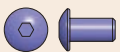

4x 902306
SH M3x6



4x 903258
SFH M2.5x8

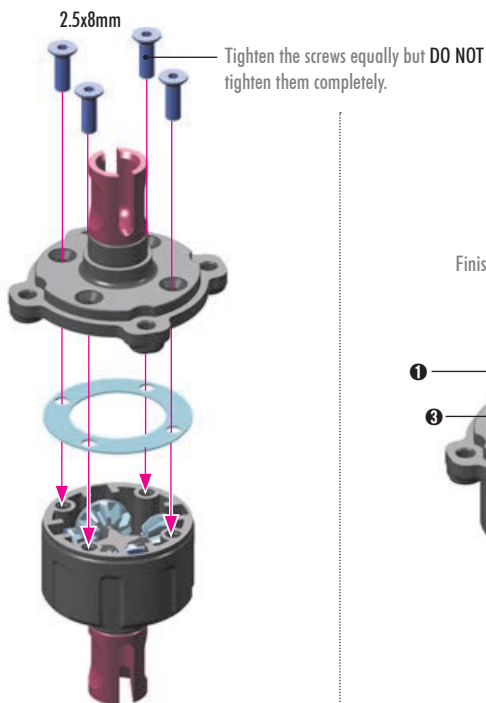

Finish tightening in this order.

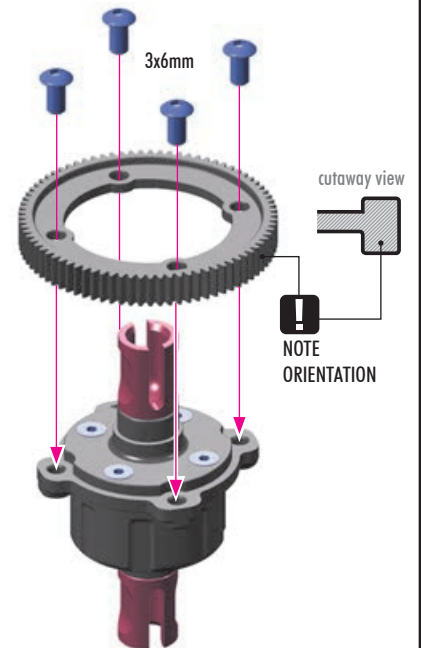
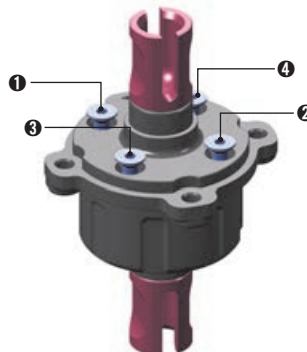

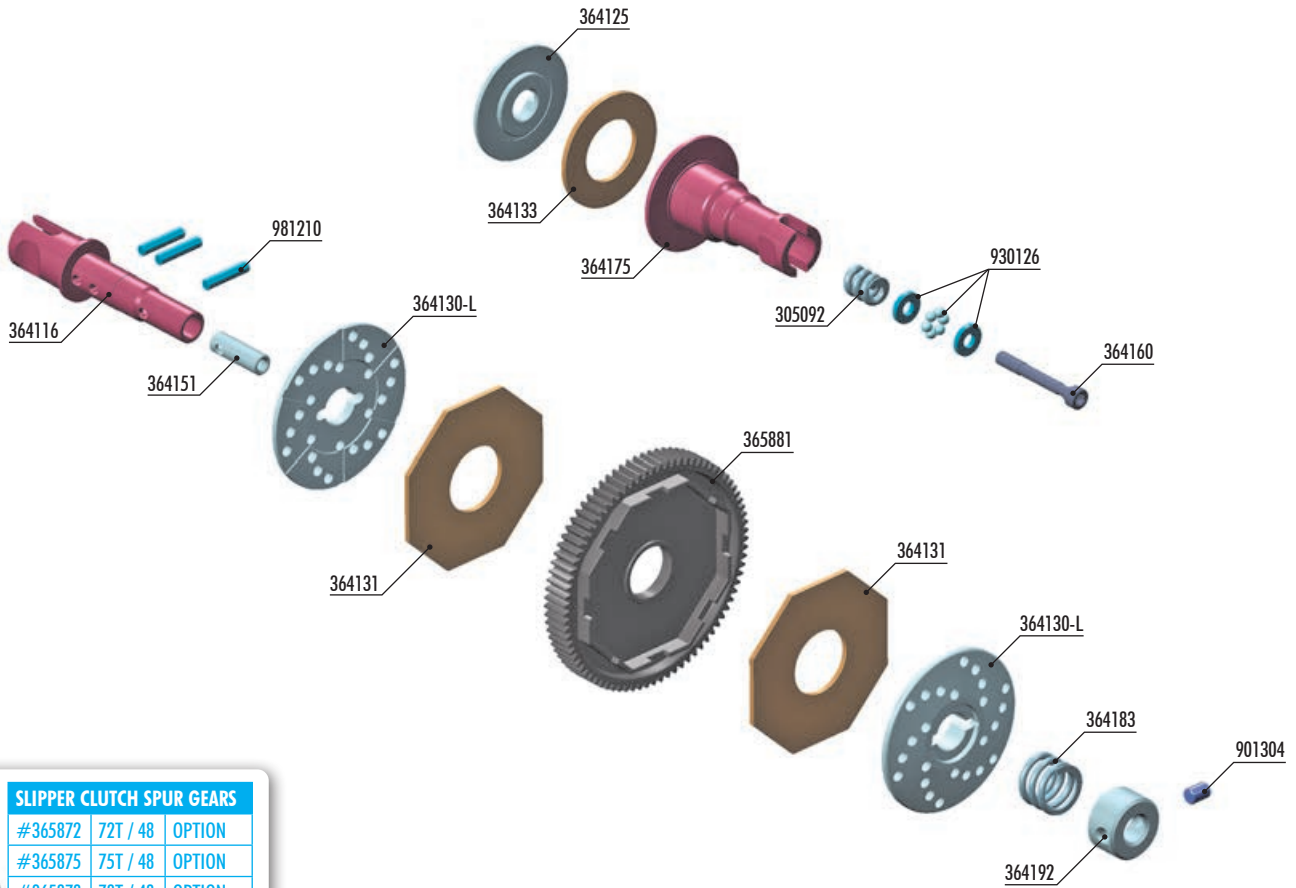

SLIPPER CLUTCH SPUR GEARS			
	#365872	72T / 48	OPTION
	#365875	75T / 48	OPTION
	#365878	78T / 48	OPTION
	#365881	81T / 48	INCLUDED
	#365884	84T / 48	OPTION
	#365887	87T / 48	OPTION

BAG
02

- 305092 BALL DIFFERENTIAL SPRING
- 364116 ONE-WAY SLIPPER CLUTCH SHAFT - HUDY SPRING STEEL™
- 364130-L ALU ONE-WAY SLIPPER CLUTCH PLATES - VENTILATED - SET
- 364125 ALU PLATE FOR ONE-WAY SLIPPER CLUTCH FOR OUTDRIVE - SWISS 7075 T6
- 364131 SLIPPER CLUTCH PAD SLS - SOFT (3)
- 364133 SLIPPER CLUTCH ONE-WAY OUTDRIVE PAD SLS - SOFT (2)
- 364151 STEEL BUSHING FOR ONE-WAY SLIPPER CLUTCH
- 364160 SCREW FOR ONE-WAY SLIPPER CLUTCH ADJUSTMENT - HUDY SPRING STEEL™
- 364175 OUTDRIVE ADAPTER WITH PRESSED ONE-WAY BEARING - HUDY SPRING STEEL™

- 364183 SLIPPER CLUTCH SPRING C=50 - BLACK
- 364192 ALU NUT FOR ONE-WAY SLIPPER CLUTCH
- 365881 COMPOSITE SLIPPER CLUTCH SPUR GEAR 81T / 48
- 901304 HEX SCREW SB M3x4 (10)
- 930126 CARBIDE BALL-BEARING AXIAL 2.6x6x1
- 981210 PIN 2x10 (10)

2x 981210 P 2x10

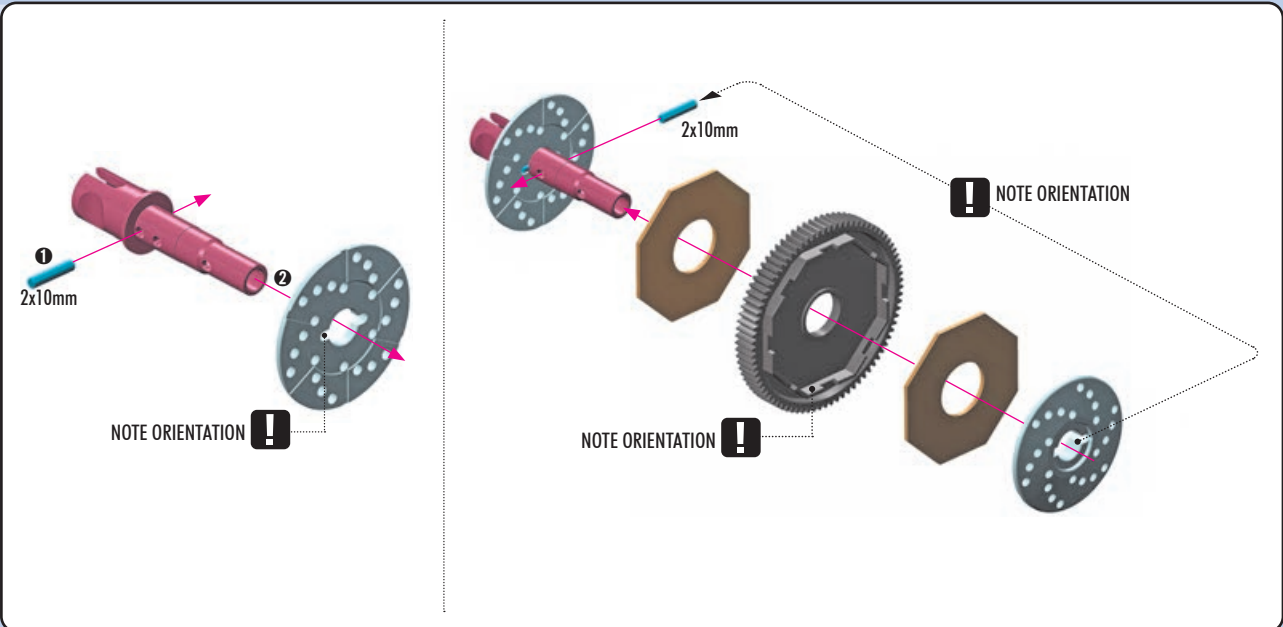

2. SLIPPER CLUTCH

CARPET

1x 901304
SB M3x4

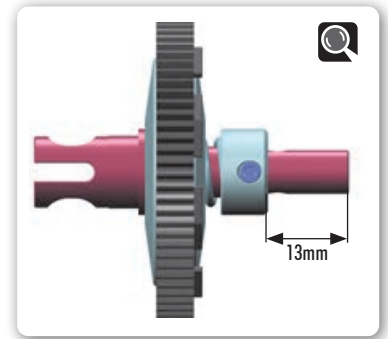
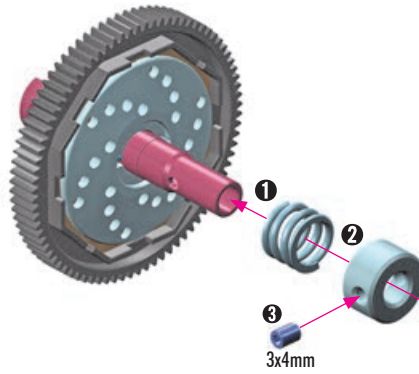

1x 980210
P 2x10

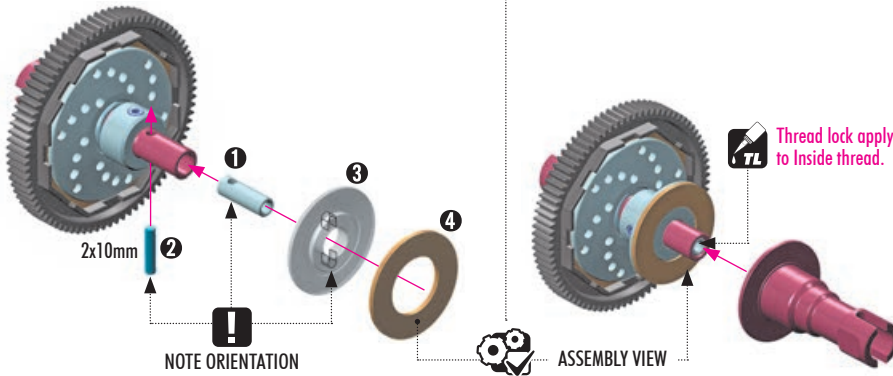

106231
HUDY ONE-WAY BEARING OIL

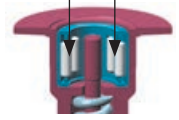

Apply a drop of One-Way Bearing Oil after every 1-2 hours of driving to increase lifespan. A dry one-way bearing may cause damage or failure.

1x 930126
BA 2.6x6x1

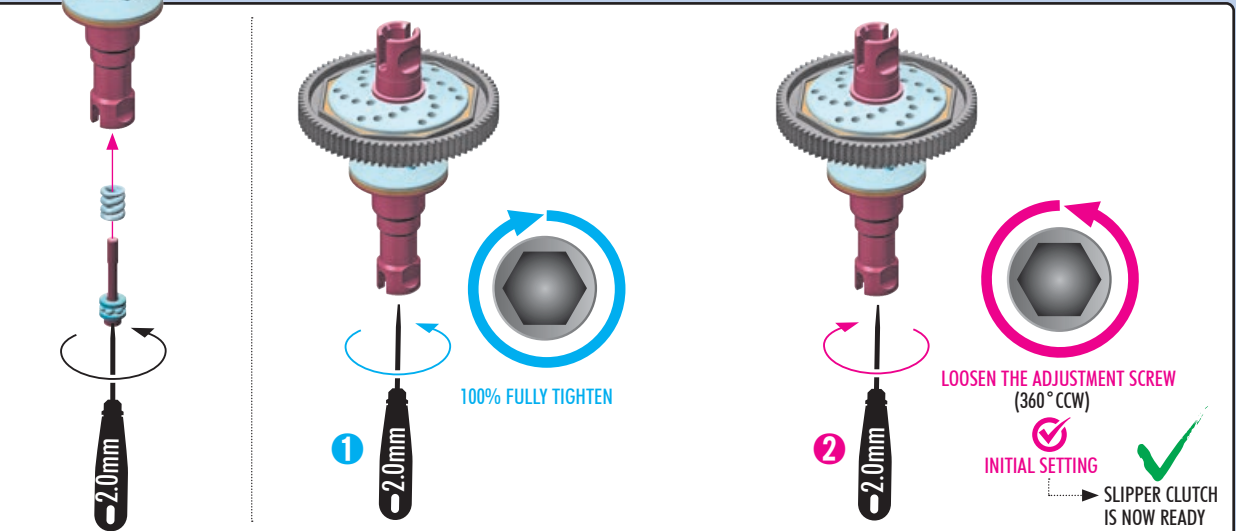
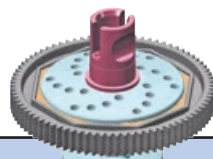
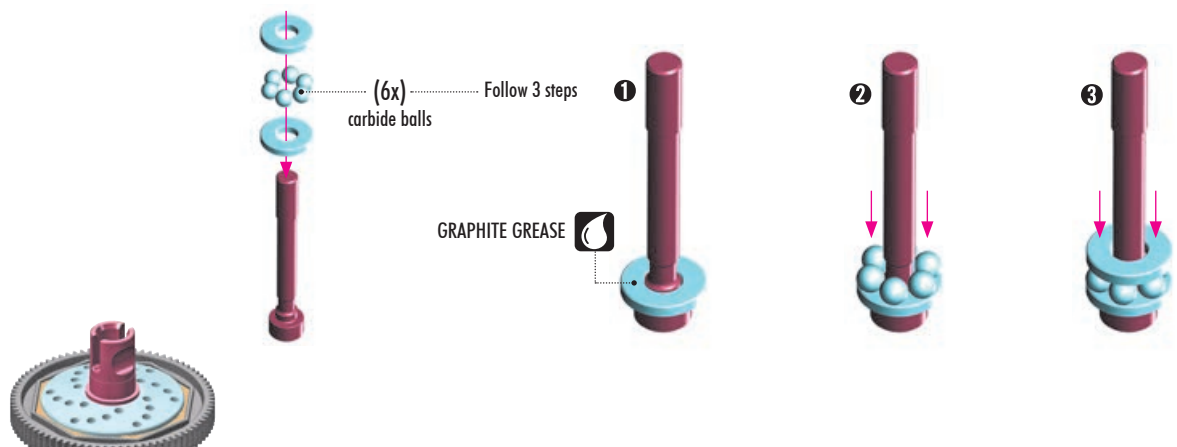

3. SHOCK ABSORBERS

CARPET

DIRT

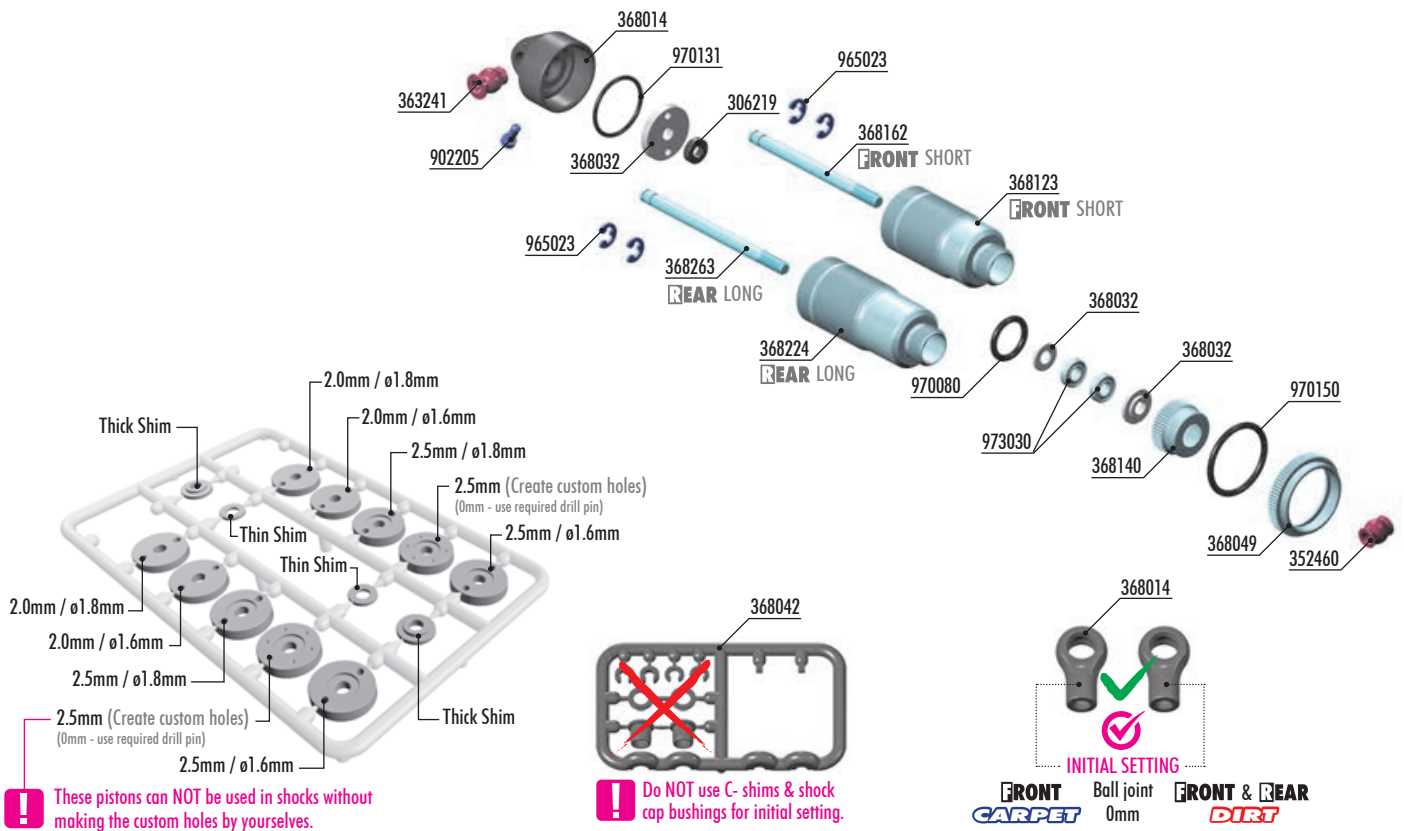

! These pistons can NOT be used in shocks without making the custom holes by yourselves.

! Do NOT use C-shims & shock cap bushings for initial setting.

INITIAL SETTING
 Ball joint 0mm
FRONT CARPET **FRONT & REAR DIRT**

BAG

03

- 306219 COMPOSITE SET OF SERVO SHIMS (4)
- 352460 PIVOT BALL 5.8 (10)
- 363241 BALL UNIVERSAL 5.8mm WITH BACKSTOP (2)
- 368014 COMPOSITE SHOCK CAP, SPRING COLLAR & BALL JOINT - BIG BORE (2)
- 368032 SHOCK PISTONS - COMPLETE SET - DELRIN - BIG BORE
- 368042 COMPOSITE SHOCK BUSHING & SHIM (2+2)
- 368049 ALU SHOCK ADJUSTABLE NUT - BIG BORE (2)
- 368102 FRONT SHOCK ABSORBERS 30mm - BIG BORE - SET (2)
- 368123 ALU FRONT SHOCK BODY 30mm - BIG BORE (2)
- 368140 ALU LOWER SHOCK BODY CAP (2)

- 368162 FRONT HARDENED SHOCK SHAFT 40mm (2)
- 368202 REAR SHOCK ABSORBERS 35.5mm - BIG BORE - SET (2)
- 368224 ALU REAR SHOCK BODY 35.5mm - BIG BORE (2)
- 368263 REAR HARDENED SHOCK SHAFT 45mm (2)
- 902205 HEX SCREW SH M2x5 (10)
- 965023 E-CLIP 2.3 (10)
- 970080 O-RING 8x1 (10)
- 970131 O-RING 13 x 1.0 (10)
- 970150 O-RING 15 x 1.5 (10)
- 973030 SILICONE X-RING PRE-OILED 3x2 (8)

CARPET

368384 **CARPET** ...
FRONT SPRINGS

... 368484 **CARPET**
REAR SPRINGS

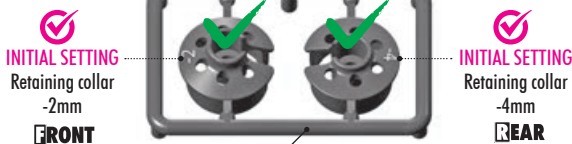
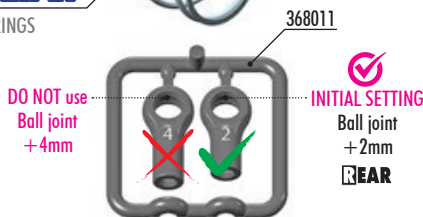

DIRT

368383 **DIRT** ...
FRONT SPRINGS

... 368482 **DIRT**
REAR SPRINGS

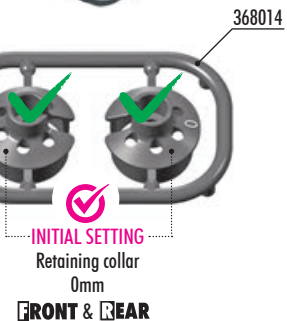
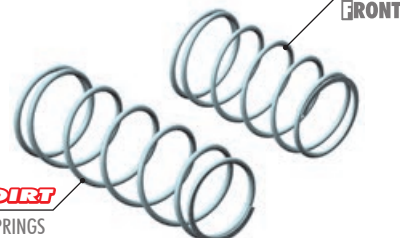

BAG

03.1

- 368011 COMPOSITE SHOCK BALL JOINT +2mm & +4mm (2+2)
- 368024 COMPOSITE SPRING COLLAR -2mm & -4mm - BIG BORE (2+2)
- 368384 FRONT CONICAL SPRING-SET L=42.5mm - 4 DOTS (2)
- 368484 REAR CONICAL SPRING-SET L=57.5mm - 4 DOTS (2)

BAG

03.1

- 368014 SHOCK CAP, SPRING COLLAR & BALL JOINT - BIG BORE (2)
- 368383 FRONT CONICAL SPRING-SET L=42.5mm - 3 DOTS (2)
- 368482 REAR CONICAL SPRING-SET L=57.5mm - 2 DOTS (2)

3. SHOCK ABSORBERS

CARPET **DIRT**

8x 965023
C2.3

CARPET **PISTONS ALTERNATIVE 1**

We recommend for these types of surfaces and traction levels:
CARPET •

FRONT

2x **FRONT SHORT SHOCK SHAFT**

ø1.6mm holes

NOTE ORIENTATION!

INITIAL PISTON SETTING **REAR** 2.5mm ø1.8mm **FRONT** 2.5mm ø1.6mm

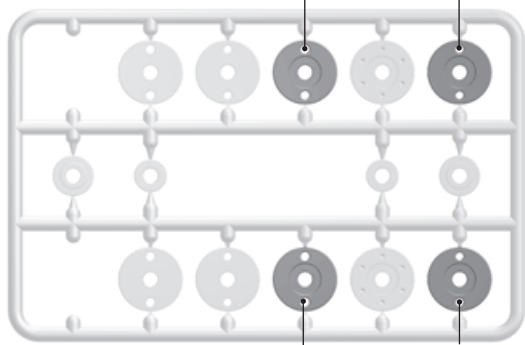

REAR

2x **REAR LONG SHOCK SHAFT**

ø1.8mm holes

NOTE ORIENTATION!

REAR 2.5mm ø1.8mm **FRONT** 2.5mm ø1.6mm

DIRT **PISTONS ALTERNATIVE 2**

We recommend for these types of surfaces and traction levels:
• ASTRO
• DIRT

FRONT

2x **FRONT SHORT SHOCK SHAFT**

ø1.6mm holes

INITIAL PISTON SETTING **REAR** 2.0mm ø1.8mm **FRONT** 2.0mm ø1.6mm

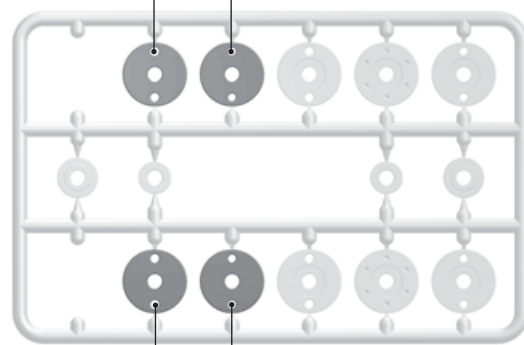

REAR

2x **REAR LONG SHOCK SHAFT**

ø1.8mm holes

REAR 2.0mm ø1.8mm **FRONT** 2.0mm ø1.6mm

4x 970080
O 8x1

8x 973030
X 3x2

There are two different thickness shims, use them as shown. Use the same procedure when building both front and rear shocks.

THICK Shim

SILICONE OIL

THIN Shim

2x **REAR LONG SHOCK BODY**

2x **FRONT SHORT SHOCK BODY**

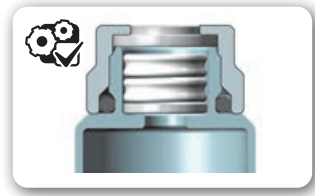
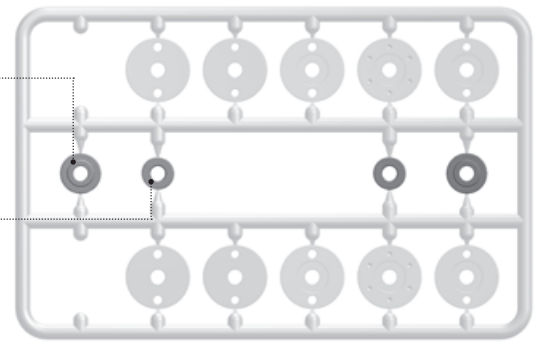

3. SHOCK ABSORBERS

CARPET

DIRT

2x FRONT 2x REAR

SHORT SHOCK SHAFT **LONG SHOCK SHAFT**

FRONT SHORT SHOCK BODY **REAR LONG SHOCK BODY**

INCORRECT **EXTREMELY IMPORTANT** **CORRECT**

DO NOT PUSH the shock rod straight through the lower shock body assembly; X-ring damage may result.

4x 970150
0 15x1.5

4x

OIL

Install the pivot balls with #183011 HUDY Multi Tool

REAR 2x + 2mm CARPET

REAR 2x 0mm DIRT

FRONT 2x 0mm CARPET DIRT

20mm FRONT

25mm REAR

! Check that Front and Rear shock pairs are the same overall length.

4x 970131
0 13x1

4x

#368054 ALU SHOCK CAP-NUT - BIG BORE (2) OPTION

Alu upper shock cap ensure increased durability and extended life time. Machined from premium Swiss 7075 T6 aluminum and additionally black coated. The shock caps feature vent hole.

4x

3. SHOCK ABSORBERS

CARPET **DIRT**

OIL
CARPET
• CARPET
• ASTRO
Front (short)
Oil 350cSt
Rear (long)
Oil 300cSt

OIL
DIRT
• DIRT
• ASTRO WET
Front (short)
Oil 350cSt
Rear (long)
Oil 300cSt

4x 902205
SH M2x5

INITIAL SHOCK REBOUND SETTING 0% REBOUND INITIAL SETTING

Follow the steps below to set the shock rebound to the default setting of 0%.

Oil level after filling
CORRECT FILING **INCORRECT FILING**

- Extend the shock shaft completely. Fill the shock body with the shock oil. For the **FRONT** shocks (short) use 350cSt oil. For the **REAR** shocks (long) use 300cSt oil.
- Move the shock shaft up and down a few times to release the air bubbles trapped beneath the piston. 3~5x UP & DOWN
- Orient the filled shock vertically for several minutes with the shock shaft fully extended. The remaining air bubbles will release.
- TIGHTEN FULLY
Gently place the shock cap onto the filled shock body and start to tighten the cap. Tighten the cap fully.
- Gently push the shock shaft completely into the shock body. Excess oil will flow through the hole in the shock cap.
- Keep the shock shaft pushed in the shock body and insert the screw into the shock cap. Tighten gently. 2x5mm
- 6x push the shaft up and down. 6x UP & DOWN
- Untighten the screw.
- Gently push the shock shaft completely into the shock body. Excess oil will flow through the hole in the shock cap.
- Tighten the screw. The rebound will be at approx. 0%

2x FRONT
2x REAR

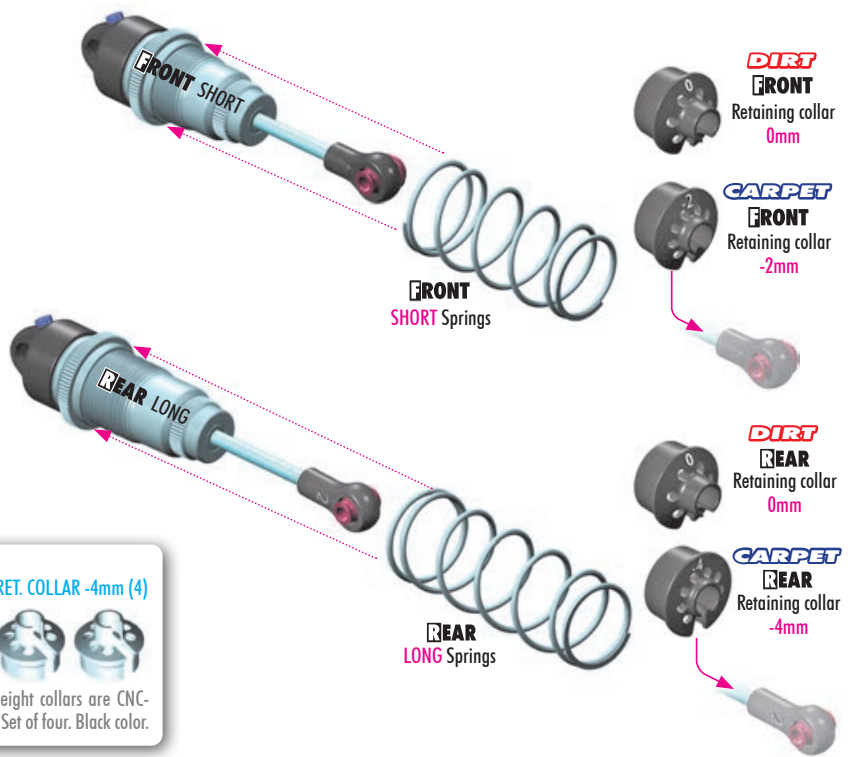
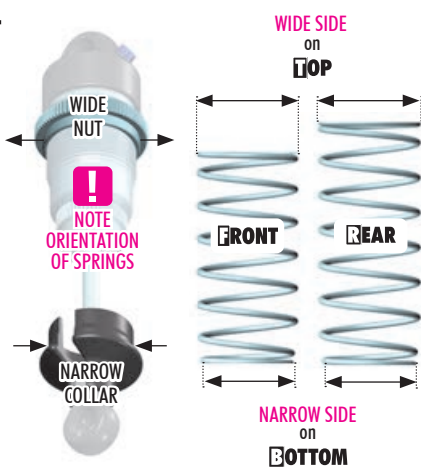

- #368021 ALU SHOCK SPRING RET. COLLAR (4) **OPTION**
- #368023 ALU SHOCK SPRING RET. COLLAR -4mm (4) **OPTION**
- #368022 ALU SHOCK SPRING RET. COLLAR -2mm (4) **OPTION**

Set of lower aluminum shock collars for increased reliability. Stylish and lightweight collars are CNC-machined from premium Swiss 7075 T6 aluminum and are strategically lightened. Set of four. Black color.

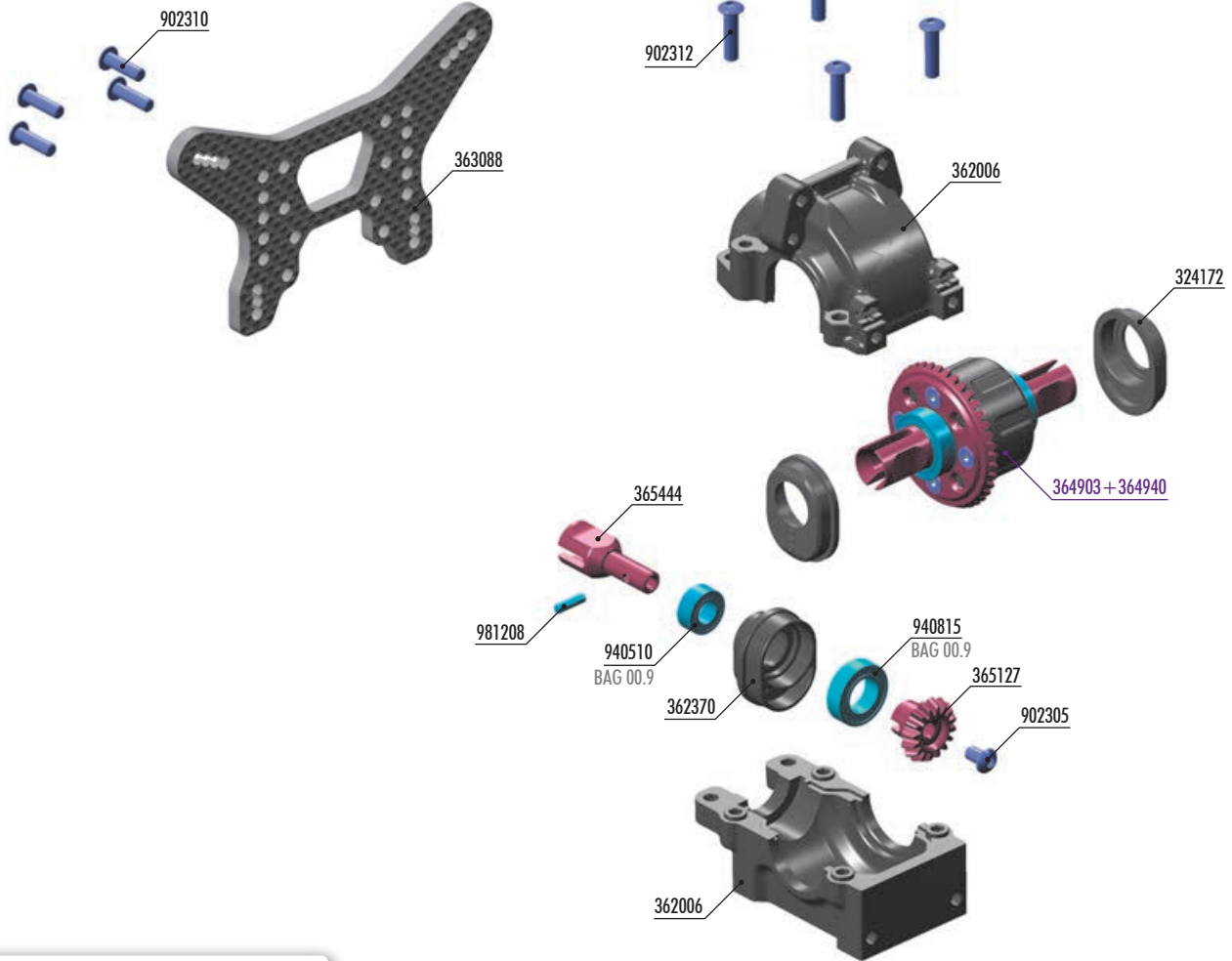
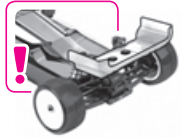

XRAY BALL-BEARINGS			
OPTION	#359050	5x10x4	GREASE
	#940510	5x10x4	OIL
	#940814	8x14x4	GREASE
	#940815	8x14x4	OIL

BALL-BEARING HUBS			
OPTION	#324172	1 DOT	OPTION
	#324172	2 DOTS	OPTION
	#324172	3 DOTS	INCLUDED

INLINE HUBS - REAR			
OPTION	#362370	1 DOT	OPTION
	#362370	2 DOTS	OPTION
	#362370	3 DOTS	INCLUDED

OPTION #365100 XRAY XB4 ACTIVE DIFFERENTIAL FRONT/REAR - SET



ACTIVE DIFF SEGMENTS			
OPTION	#325123	60°	OPTION
	#325125	90°	INCLUDED
	#325127	120°	OPTION



- 324172 COMPOSITE ADJUSTMENT BALL-BEARING HUB (2)
- 362006 DIFF BULKHEAD - HORIZONTAL SPLIT DESIGN (HS) - FRONT/REAR - SET
- 362370 INLINE HUB FOR BEVEL DRIVE GEAR - REAR HS BULKHEAD - 1+2+3 DOTS
- 363088 CARBON SHOCK TOWER FOR HS BULKHEAD - 3-DOTS - REAR
- 365127 STEEL BEVEL DRIVE GEAR - FOR HS BULKHEAD - CNC-MACHINED - 16T
- 365444 CENTRAL DOGBONE SHAFT UNIVERSAL JOINT - HUDY SPRING STEEL™

- 902305 HEX SCREW SH M3x5 (10)
- 902310 HEX SCREW SH M3x10 (10)
- 902312 HEX SCREW SH M3x12 (10)
- 940510 BALL-BEARING 5x10x4 RUBBER SEALED - OIL (2)
- 940815 BALL-BEARING 8x14x4 RUBBER SEALED - OIL (2)
- 981208 PIN 2x8 (10)
- 364903 GEAR DIFFERENTIAL - LARGE VOLUME - SET
- 364940 STEEL DIFFERENTIAL BEVEL GEAR FOR LARGE VOLUME DIFF 40T

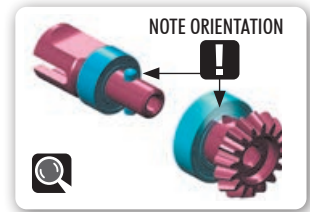
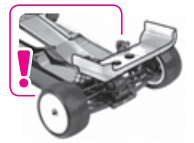
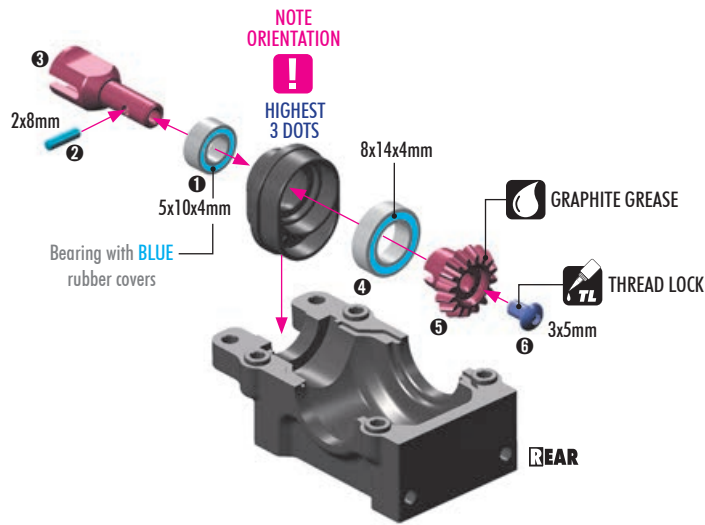
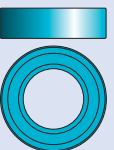

CARPET
BEVEL DRIVE GEAR & DIFFERENTIAL HEIGHT ADJUSTMENT

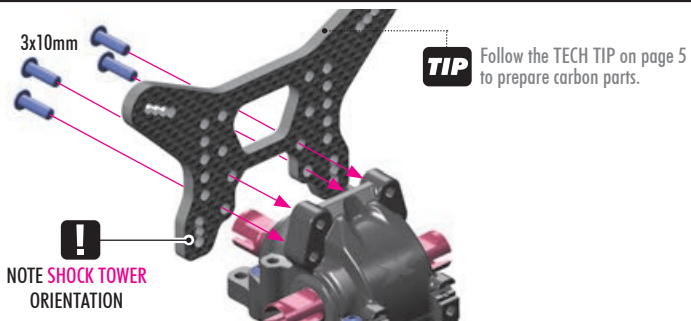
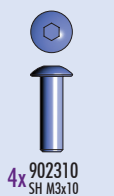
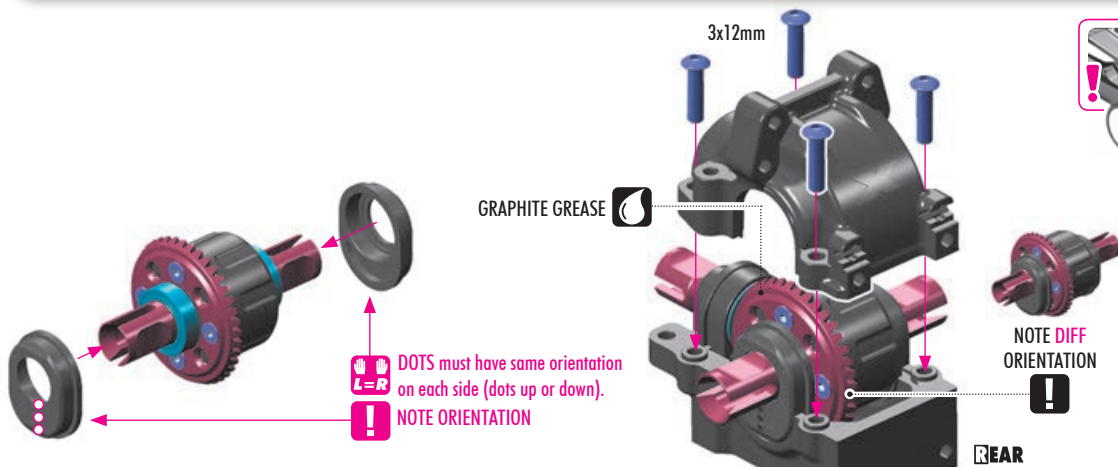
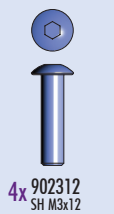
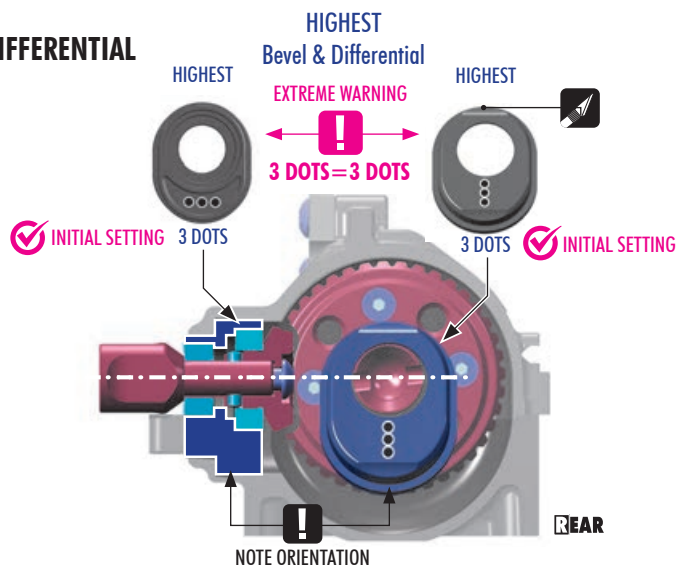



1x 940510 BB 5x10x4



1x 940815 BB 8x14x4



1x 981208 P 2x8

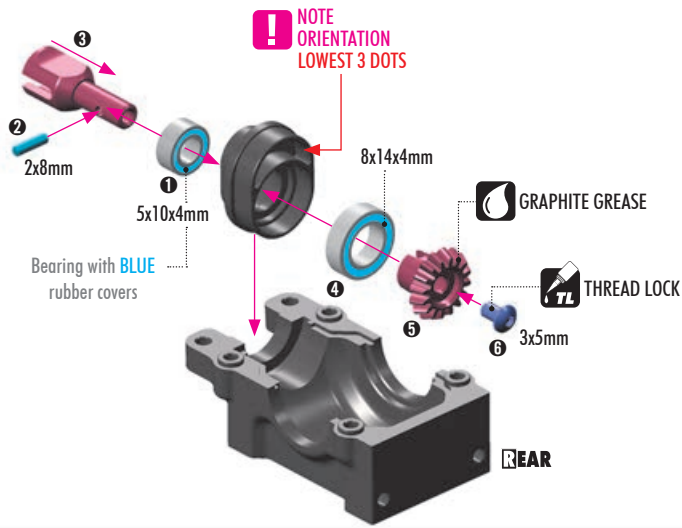

DIRT REAR BEVEL DRIVE GEAR & DIFFERENTIAL HEIGHT ADJUSTMENT

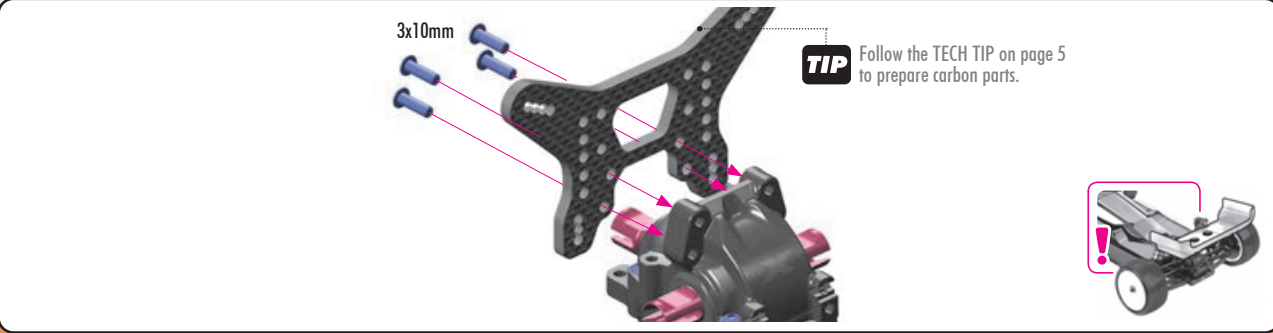
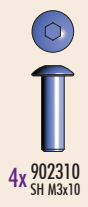
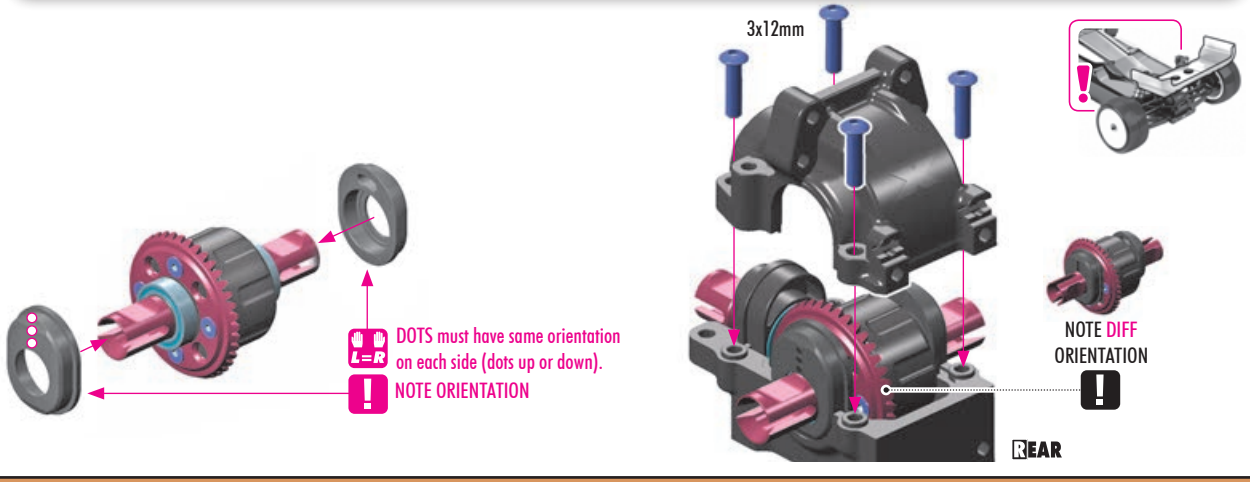
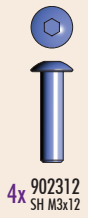
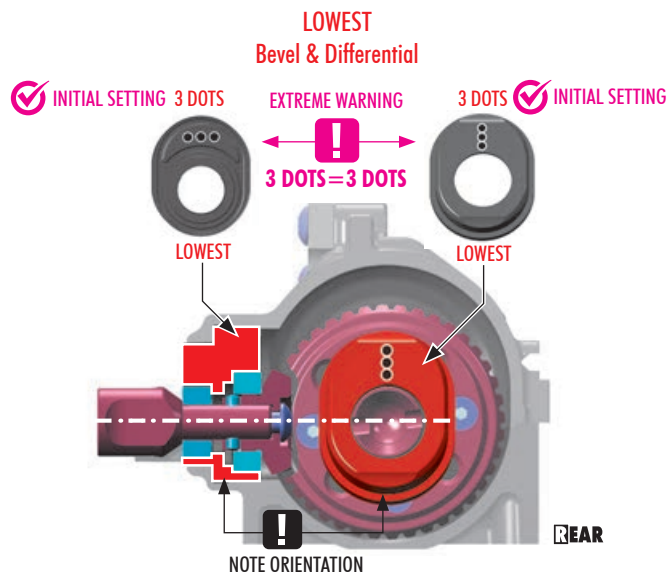

5. REAR SUSPENSION

CARPET

DIRT

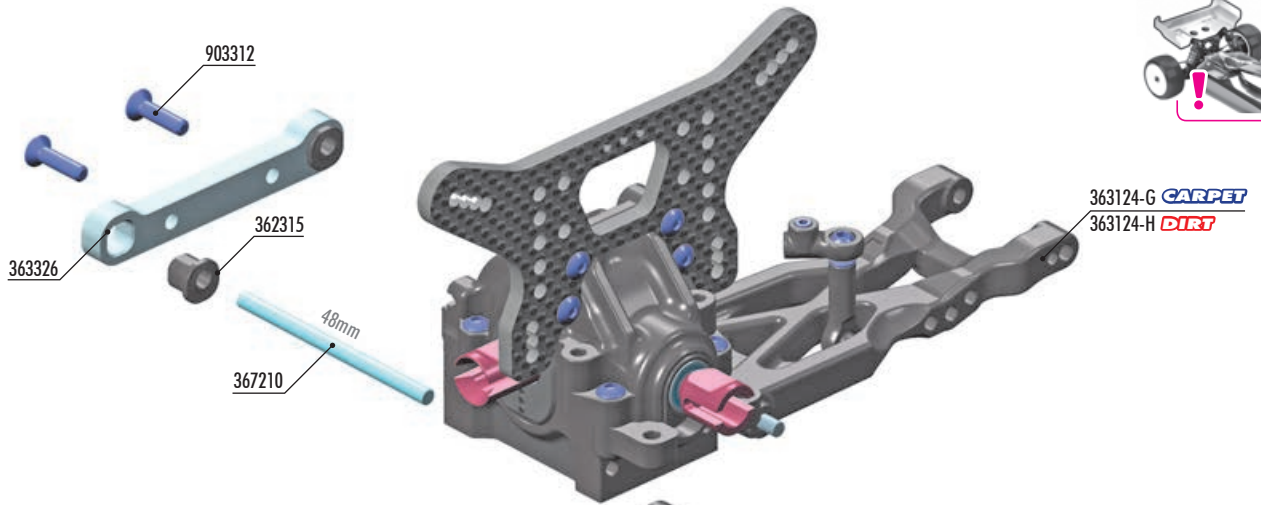

363114-G **CARPET**
363114-H **DIRT**

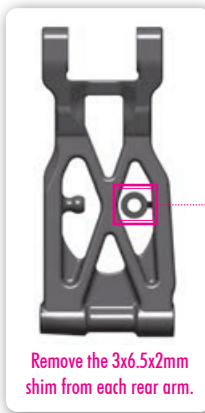
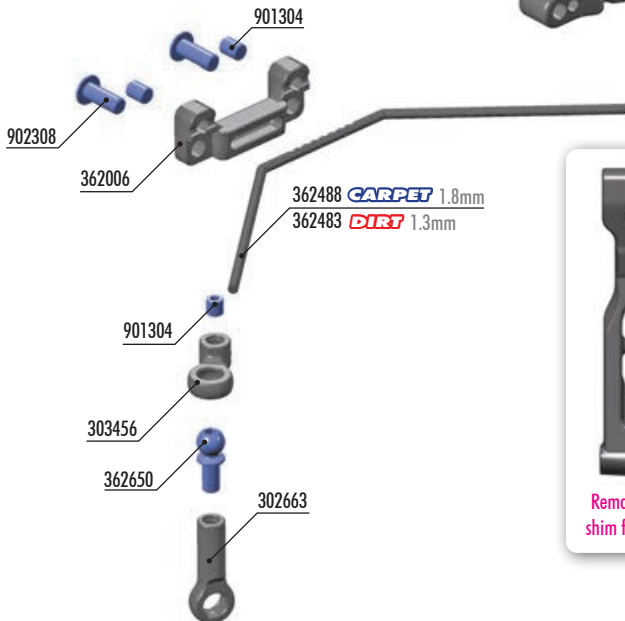
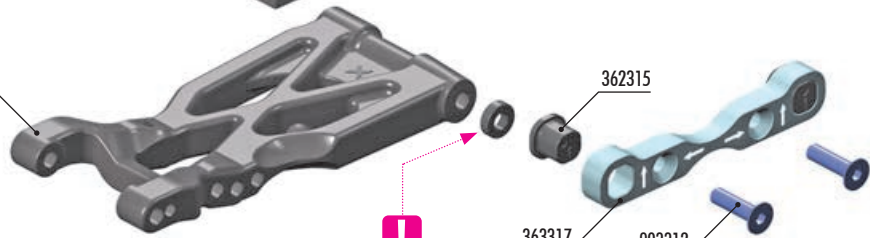

Remove the 3x6.5x2mm shim from each rear arm.

OPTION #363316
ALU LOWER SUSP. HOLDER FOR HS BULKHEAD - RF



#363325 **OPTION**
ALU LOWER SUSPENSION HOLDER FOR HS BULKHEAD - RR

OPTION **SHORT REAR SUSPENSION ARMS**

Part #	Side	Material	Status
#363114-M	RIGHT	MEDIUM	OPTION
#363124-M	LEFT	MEDIUM	OPTION
#363114-H	RIGHT	HARD	INCLUDED
#363124-H	LEFT	HARD	INCLUDED
#363114-G	RIGHT	GRAPHITE	INCLUDED
#363124-G	LEFT	GRAPHITE	INCLUDED

OPTION **LONG REAR SUSPENSION ARMS**

Part #	Side	Material	Status
#363113-M	RIGHT	MEDIUM	OPTION
#363123-M	LEFT	MEDIUM	OPTION
#363113-H	RIGHT	HARD	OPTION
#363123-H	LEFT	HARD	OPTION
#363113-G	RIGHT	GRAPHITE	OPTION
#363123-G	LEFT	GRAPHITE	OPTION

OPTION **HUDY TITAN BALL ENDS**

Part #	Size	Status
#990006	6mm Thread	OPTION

OPTION **ANTI-ROLL BARS**

Part #	Thickness	Status
#362481	1.1mm	OPTION
#362482	1.2mm	OPTION
#362483	1.3mm	INCLUDED
#362484	1.4mm	OPTION
#362486	1.6mm	OPTION
#362488	1.8mm	INCLUDED
#362489	2.0mm	OPTION

BAG
05

- 302663 COMPOSITE BALL JOINT 4.9mm - OPEN - V2 (8)
- 303456 COMPOSITE ANTI-ROLL BAR o2.0mm BALL JOINT 4.9mm (4)
- 362006 DIFF BULKHEAD BLOCK SET
- 362315 ECCENTRIC BUSHING SET (2)
- 362650 BALL END 4.9MM WITH THREAD 6mm (2)
- 363317 ALU SUSPENSION HOLDER WIDE FOR HS BULKHEAD - REAR-FRONT
- 363326 ALU SUSPENSION HOLDER WIDE FOR HS BULKHEAD - REAR-REAR
- 367210 SUSPENSION PIVOT PIN (2)
- 901304 HEX SCREW SB M3x4 (10)
- 902308 HEX SCREW SH M3x8 (10)

- 903312 HEX SCREW SFH M3x12 (10)
- DIRT**
- 362483 ANTI-ROLL BAR 1.3mm
- 363114-H COMPOSITE SUSP. ARM REAR LOWER RIGHT - 3-HOLE - HARD
- 363124-H COMPOSITE SUSP. ARM REAR LOWER LEFT - 3-HOLE - HARD
- CARPET**
- 362488 ANTI-ROLL BAR 1.8mm
- 363114-G COMPOSITE SUSP. ARM REAR LOWER RIGHT - 3-HOLE - GRAPHITE
- 363124-G COMPOSITE SUSP. ARM REAR LOWER LEFT - 3-HOLE - GRAPHITE

IO
2x From Rear Arm
SHIM 3x6.5x2

4x 903312
SFH M3x12

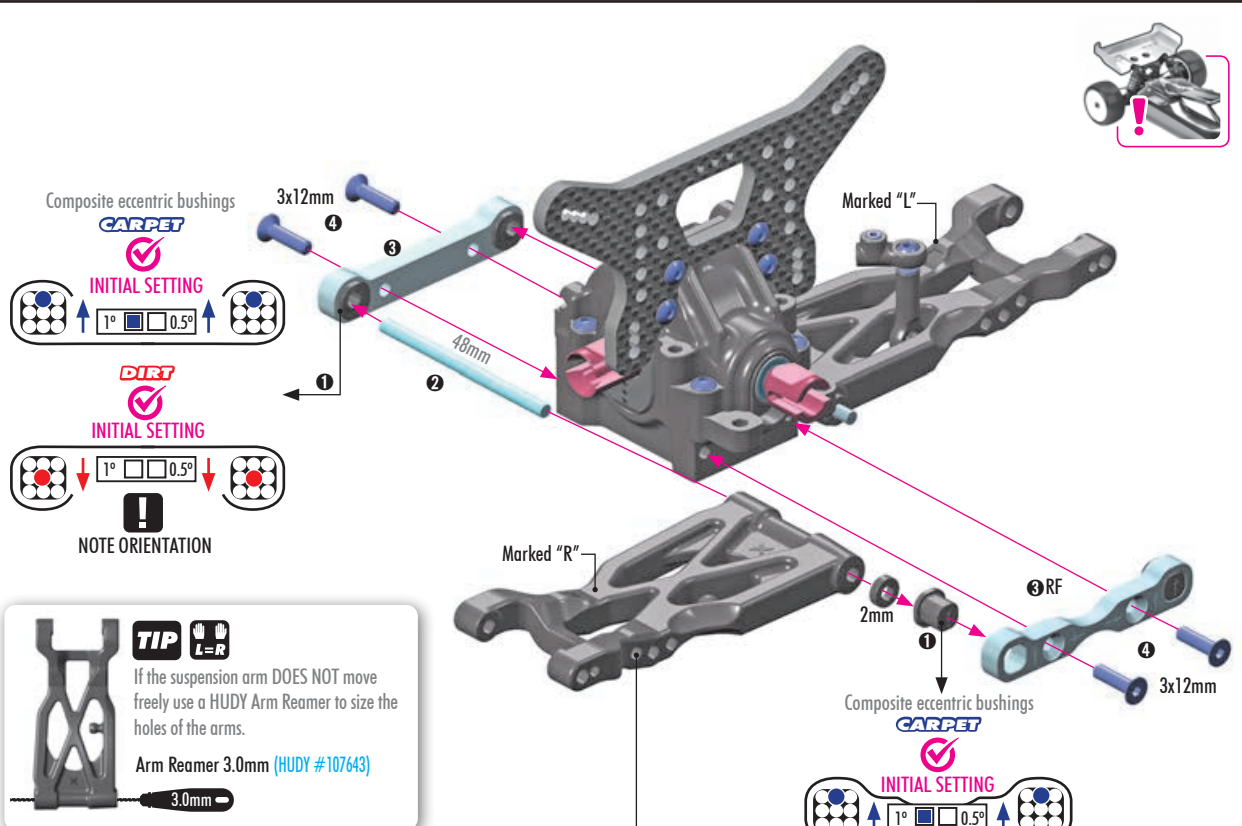

OPTION	SHORT REAR SUSPENSION ARMS			
	#363114-M	RIGHT	MEDIUM	OPTION
	#363124-M	LEFT	MEDIUM	OPTION
	#363114-H	RIGHT	HARD	INCLUDED
	#363124-H	LEFT	HARD	INCLUDED
	#363114-G	RIGHT	GRAPHITE	INCLUDED
	#363124-G	LEFT	GRAPHITE	INCLUDED

OPTION	LONG REAR SUSPENSION ARMS			
	#363113-M	RIGHT	MEDIUM	OPTION
	#363123-M	LEFT	MEDIUM	OPTION
	#363113-H	RIGHT	HARD	OPTION
	#363123-H	LEFT	HARD	OPTION
	#363113-G	RIGHT	GRAPHITE	OPTION
	#363123-G	LEFT	GRAPHITE	OPTION

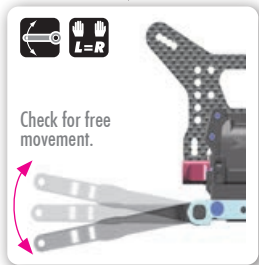

DIRT
INITIAL SETTING
NOTE ORIENTATION

#363316
ALU LOWER SUSPENS. HOLDER FOR HS BULKHEAD - RF

#363325
ALU LOWER SUSPENSION HOLDER FOR HS BULKHEAD - RR

ECCENTRIC BUSHINGS HAVE TWO DIFFERENT OFFSETS FROM THE CENTER.



The XRAY rear alu lower suspension holders provide great range of adjustment for the rear suspension. Using different combinations of eccentric bushings, fine adjustment of rear anti-squat, rear toe-in, rear roll center, and rear track-width can be obtained. For more information about the influence of rear anti-squat, rear toe-in, rear roll center and rear track width on car handling, please refer to HUDY Set-up Book (#209100).

ANTI-SQUAT		
RR	RF	(°)
		=2°
		=3°
		=1°
		=3°
		=2°
		=4°
		=1°
		=2°
		=0°

ROLL CENTER		
RR	RF	(mm)
		=+0.75mm
		=0mm
		=-0.75mm

TRACK-WIDTH		
RR	RF	(mm)
		=+1.5mm
		=0mm
		=-1.5mm

TOE-IN		
RR	RF	(°)
		=3°
		=4°
		=2°
		=3°
		=2°
		=1°
		=4°
		=5°
		=3°

The tables describe the amounts of adjustment using the center and outside positions of the eccentric bushings. The middle position eccentric bushings allow for finer adjustment increments.

The track-width is directly influenced by the size of the wheels and tires used.

LEFT = RIGHT

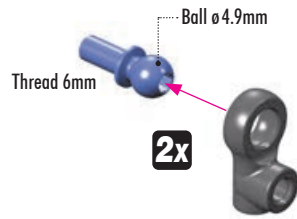

TIP Install with HUDY Multi Tool.

HUDY TITAN BALL ENDS
 OPTION #990006 | 6mm Thread | OPTION

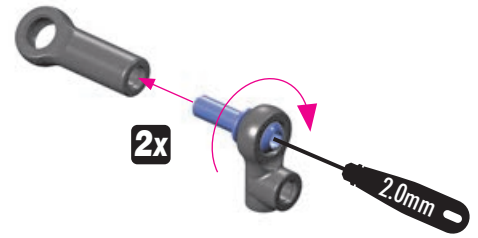

4x 901304 SB M3x4

2x 902308 SH M3x8

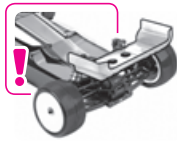

OPTION	ANTI-ROLL BARS		
OPTION	#362481	1.1mm	OPTION
OPTION	#362482	1.2mm	OPTION
	#362483	1.3mm	INCLUDED
OPTION	#362484	1.4mm	OPTION
OPTION	#362486	1.6mm	OPTION
OPTION	#362488	1.8mm	INCLUDED
OPTION	#362489	2.0mm	OPTION

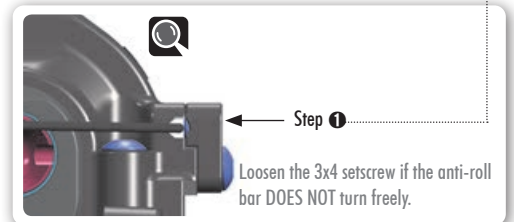
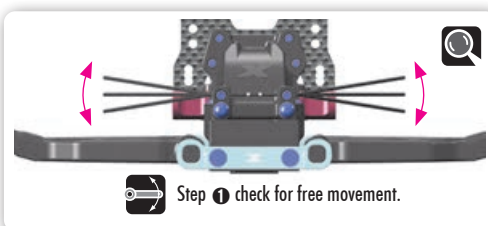
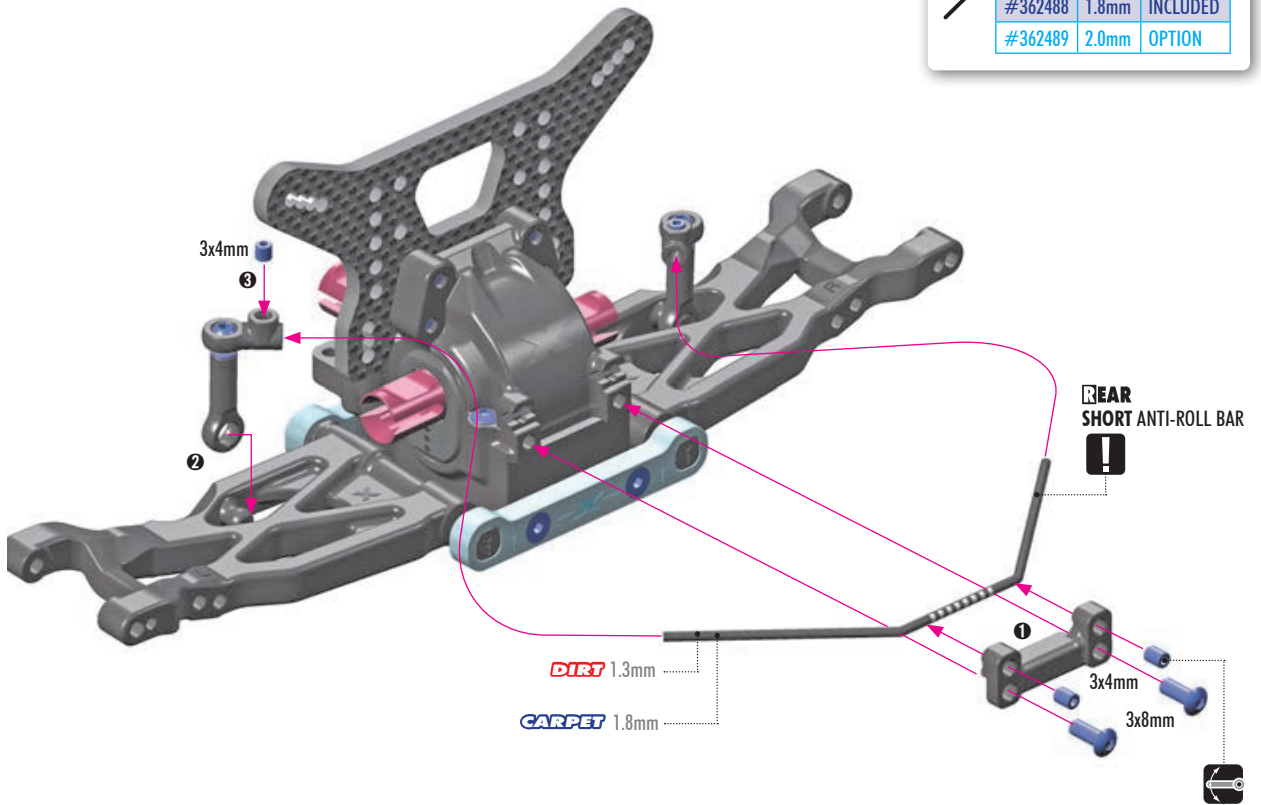

! Remaining ball joints will be used in the next sections of the instruction manual.

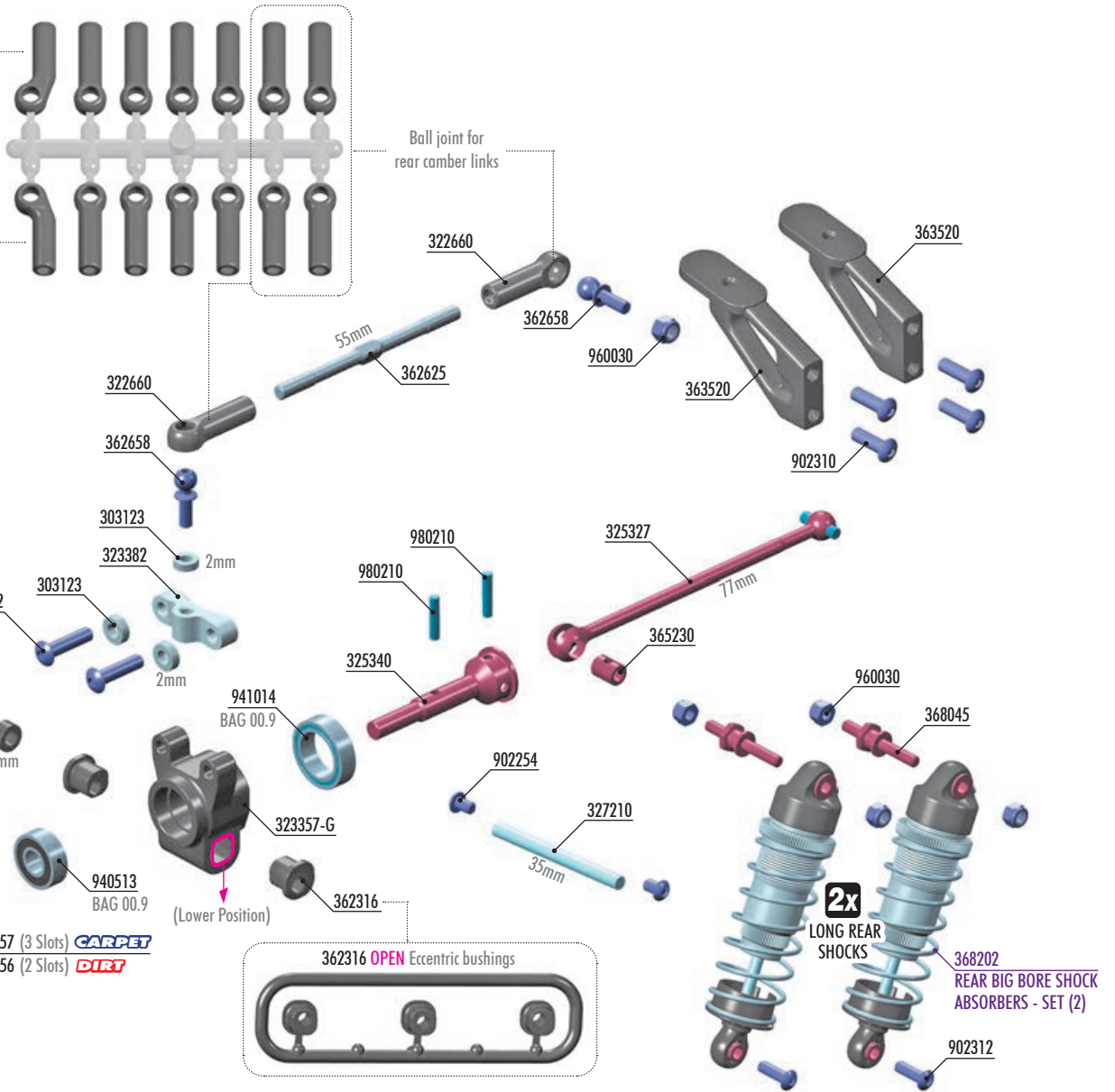

BAG

06

- | | | | |
|----------|---|---------------|--|
| 303123 | ALU SHIM 3x6x2.0mm (10) | 902205 | HEX SCREW SH M2x5 (10) |
| 306219 | COMPOSITE SET OF SERVO SHIMS (4) | 902254 | HEX SCREW SH M2.5x4 (10) |
| 322660 | COMPOSITE BALL JOINT 5.4mm (12+1+1) | 902310 | HEX SCREW SH M3x10 (10) |
| 323357-G | COMPOSITE UPRIGHT REAR - LOWER POSITION - GRAPHITE | 902312 | HEX SCREW SH M3x12 (10) |
| 323382 | ALU REAR HUB PLATE FOR MULTI ADJ. UPRIGHT - 1-HOLE | 940513 | BALL-BEARING 5x12x4 RUBBER SEALED - GREASE (2) |
| 325327 | REAR DRIVE SHAFT 77mm WITH 2.5mm PIN - SPRING STEEL™ | 941014 | BALL-BEARING 10x15x4 RUBBER SEALED - GREASE (2) |
| 325340 | REAR DRIVE AXLE LB - HUDY SPRING STEEL™ | 960030 | NUT M3 (10) |
| 327210 | FRONT SUSPENSION PIVOT PIN (2) | 980210 | PIN 2x10 (10) |
| 362316 | OPEN ECCENTRIC BUSHING SET (2) | CARPET | |
| 362625 | ADJUSTABLE TURNBUCKLE 55mm M3.5 L/R - HUDY SPRING STEEL™ (2) | 365357 | ALU WHEEL HUB 12mm - OFFSET "+2.25mm" (2) |
| 362658 | HARD STEEL BALL END 5.4mm WITH THREAD 8mm - NICKEL COATED (2) | DIRT | |
| 363520 | REAR WING POST - V2 (2) | 365356 | ALU WHEEL HUB 12mm - OFFSET "+1.5mm" (2) |
| 365230 | DRIVE SHAFT COUPLING - HUDY SPRING STEEL™ | 368202 | REAR SHOCK ABSORBERS 35.5mm - BIG BORE - SET (2) |
| 368045 | STEEL SCREW SHOCK PIVOT BALL WITH HEX (2) | | |

Included only in **CARPET** Edition

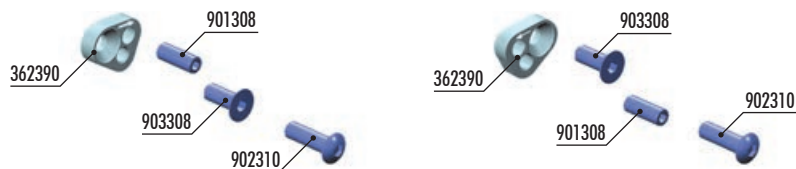

BAG

06.1

- | | |
|---|---|
| XB4 FINAL SHOCK ASSEMBLY SET CARPET | |
| 362390 | ALU REAR SHOCK ABSORBER ADAPTER (1+1) - SET |
| 901308 | HEX SCREW SB M3x8 (10) |
| 902310 | HEX SCREW SH M3x10 (10) |
| 903308 | HEX SCREW SFH M3x8 (10) |

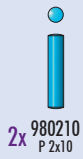

2x 980210 P 2x10

2x LEFT = RIGHT
1 2 3 SPECIFIC ORDER STEPS

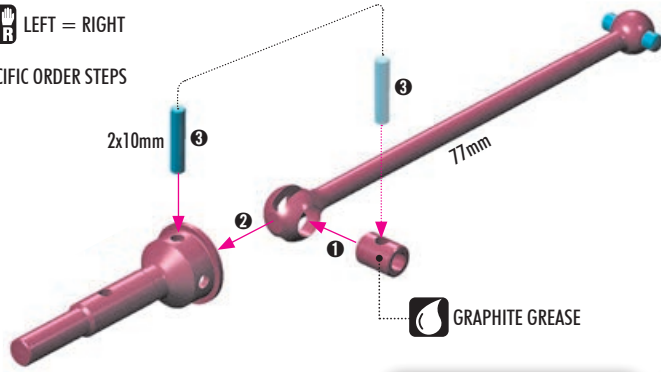

GRAPHITE GREASE

OPTION #305231 DRIVE SHAFT COUPLING HUDY SPRING STEEL

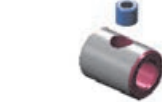

! EXTREMELY IMPORTANT

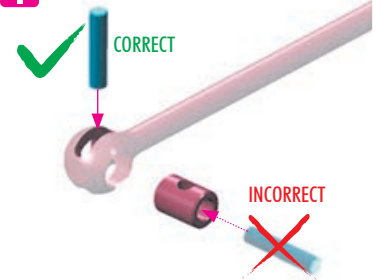

OPTION #325341 REAR ADJ. DRIVE AXLE LB - HUDY SPRING STEEL™
 #325390 ALU SHIM 10x12x2mm (2)



Drive shaft length adjustment uses 4 different connecting hole positions at the drive axle end to allow changes to overall driveshaft length.

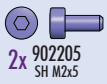

2x 902205 SH M2x5

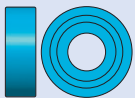

2x 940513 BB 5x12x4



2x 941014 BB 10x15x4

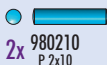

2x 980210 P 2x10

2x LEFT = RIGHT
1 2 3 SPECIFIC ORDER STEPS

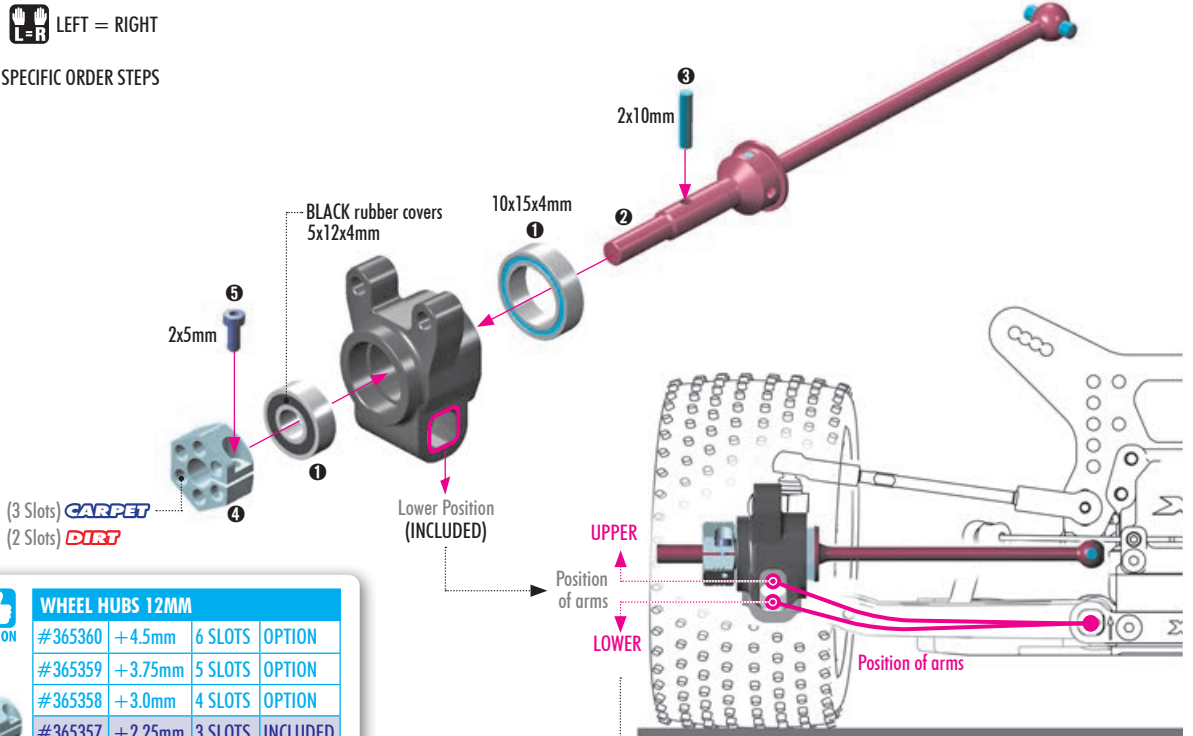

OPTION

WHEEL HUBS 12MM			
#365360	+4.5mm	6 SLOTS	OPTION
#365359	+3.75mm	5 SLOTS	OPTION
#365358	+3.0mm	4 SLOTS	OPTION
#365357	+2.25mm	3 SLOTS	INCLUDED
#365356	+1.5mm	2 SLOTS	INCLUDED
#365355	+0.75mm	1 SLOT	OPTION
#365353	0mm	0 SLOTS	OPTION
#365354	-0.75mm	Lightw.	OPTION
#365361	-1.25mm	Lightw.	OPTION

OPTIONAL HEX HUB EFFECTS

Different offset hex hubs are used to increase or decrease the track-width.

LESS OFFSET **MORE OFFSET**
 Rear - more traction Rear - less traction
 Front - more steering Front - less steering

OPTION

XRAY BALL-BEARINGS			
#940512	5x12x4	OIL	OPTION
#941015	10x15x4	OIL	OPTION
#940513	5x12x4	GREASE	INCLUDED
#941014	10x15x4	GREASE	INCLUDED

OPTION

REAR UPRIGHTS			
		Position	
#323354-M	MEDIUM	UPPER	OPTION
#323357-M	MEDIUM	LOWER	OPTION
#323354-H	HARD	UPPER	OPTION
#323354-G	GRAPHITE	UPPER	OPTION
#323357-G	GRAPHITE	LOWER	INCLUDED
#323355	ALU HIGH	UPPER	OPTION
#323356	ALU LOW	LOWER	OPTION

UPPER position

We recommend for these types of surfaces and traction:

- DIRT low & high traction
- Wet ASTRO

LOWER position

We recommend for these types of surfaces and traction:

- CARPET
- Dry ASTRO
- DIRT very high traction

2x LEFT = RIGHT

4x OPEN
Eccentric bushings

INITIAL SETTING ORIENTATION

SIDE orientation CENTER orientation CORNER orientation

2x LEFT = RIGHT

INITIAL SETTING ORIENTATION

! L=R

Open bushings must have same orientation on each side.

4x 303123 SHIM 3x6x2

4x 902312 SH M3x12

2x LEFT = RIGHT

INITIAL SETTING ORIENTATION

Alternative orientation

2mm

3x12mm

2x 306219 SHIM 3x6x3

4x 902254 SH M2.5x4

TIP Ensure that the rear upright moves freely. If it DOES NOT move freely, use sandpaper to thin both wheelbase adjustment shims.

SHORTER WHEELBASE DIRT **INITIAL SETTING** Shim behind hub 3mm

LONGER WHEELBASE CARPET **INITIAL SETTING** Shim in front of hub 3mm

2.5x4mm

TIGHTEN GENTLY

35mm

2.5x4mm

TIGHTEN GENTLY

ASSEMBLED VIEW

CHECK FOR FREE MOVEMENT

2x LEFT = RIGHT

RIGHT THREAD SIDE **LEFT THREAD SIDE**

! SLOT ORIENTATION

LEFT THREAD

RIGHT THREAD

Ball ø5.4mm
Thread 8mm

TIP
Install with HUDY Multi Tool.

INITIAL SETTING
approx. 27.6mm

CARPET
DIRT

- 2x** 303123 SHIM 3x6x2
- 2x** 960030 N M3

2x LEFT = RIGHT

ASSEMBLED VIEW

2mm

INITIAL SETTING
CARPET

INITIAL SETTING
DIRT

- 4x** 902310 SH M3x10

2x LEFT = RIGHT

ASSEMBLED VIEW

3x10mm

INITIAL SETTING
CARPET
DIRT



2x LEFT = RIGHT

Steps only for **CARPET** Edition

BAG

06.1

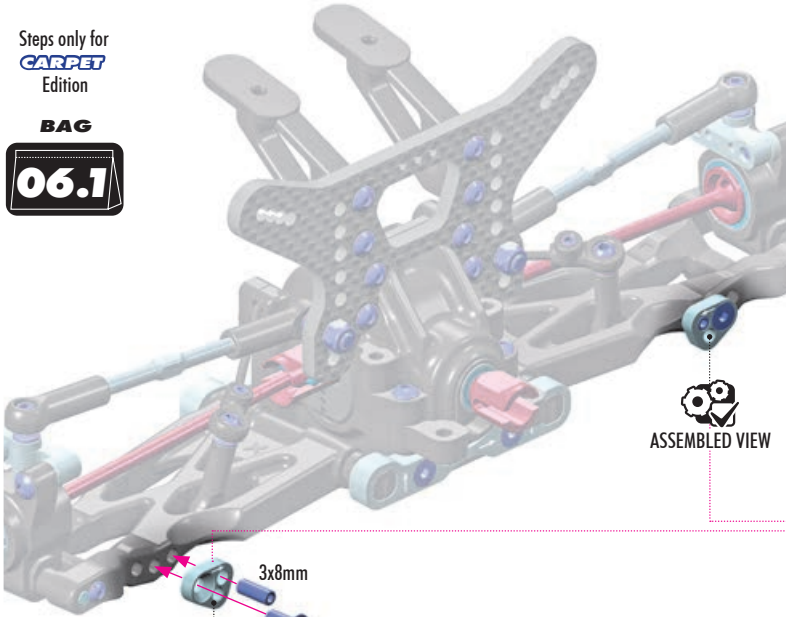

ASSEMBLED VIEW

NOTE ORIENTATION

3x8mm

3x8mm



SHOCK POSITION ALTERNATIVES

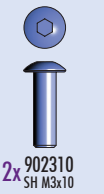
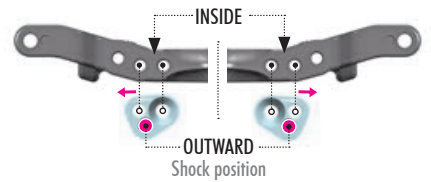
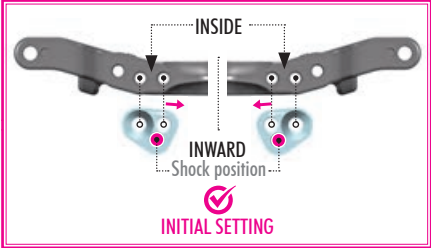
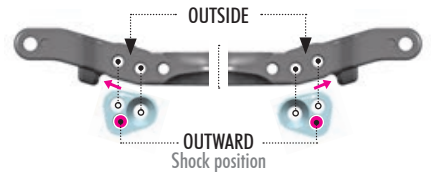
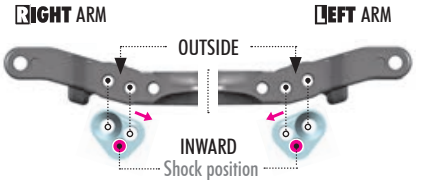

2x LEFT = RIGHT

Steps only for **CARPET** Edition

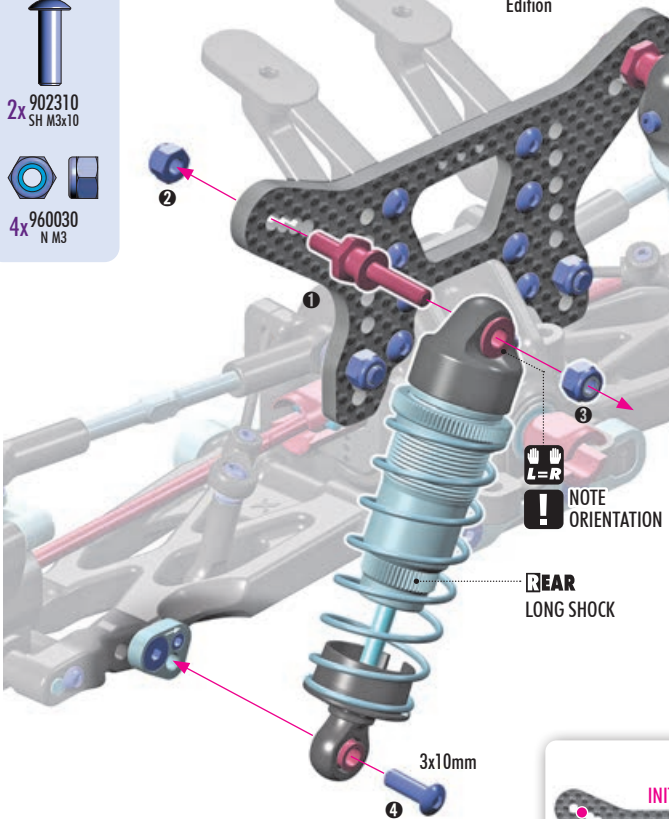

NOTE ORIENTATION

REAR LONG SHOCK

3x10mm

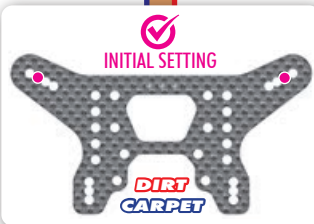

2x LEFT = RIGHT

Steps only for **DIRT** Edition

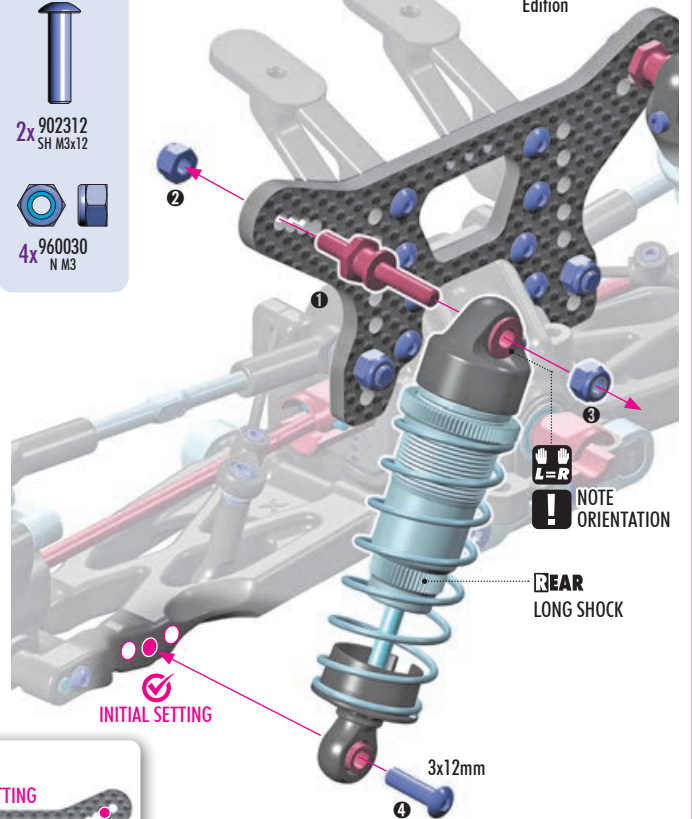

NOTE ORIENTATION

REAR LONG SHOCK

INITIAL SETTING

3x12mm

#365100
 XRAY XB4 ACTIVE DIFFERENTIAL FRONT/REAR - SET



ACTIVE DIFF SEGMENTS			
#325123	60°		OPTION
#325125	90°		INCLUDED
#325127	120°		OPTION

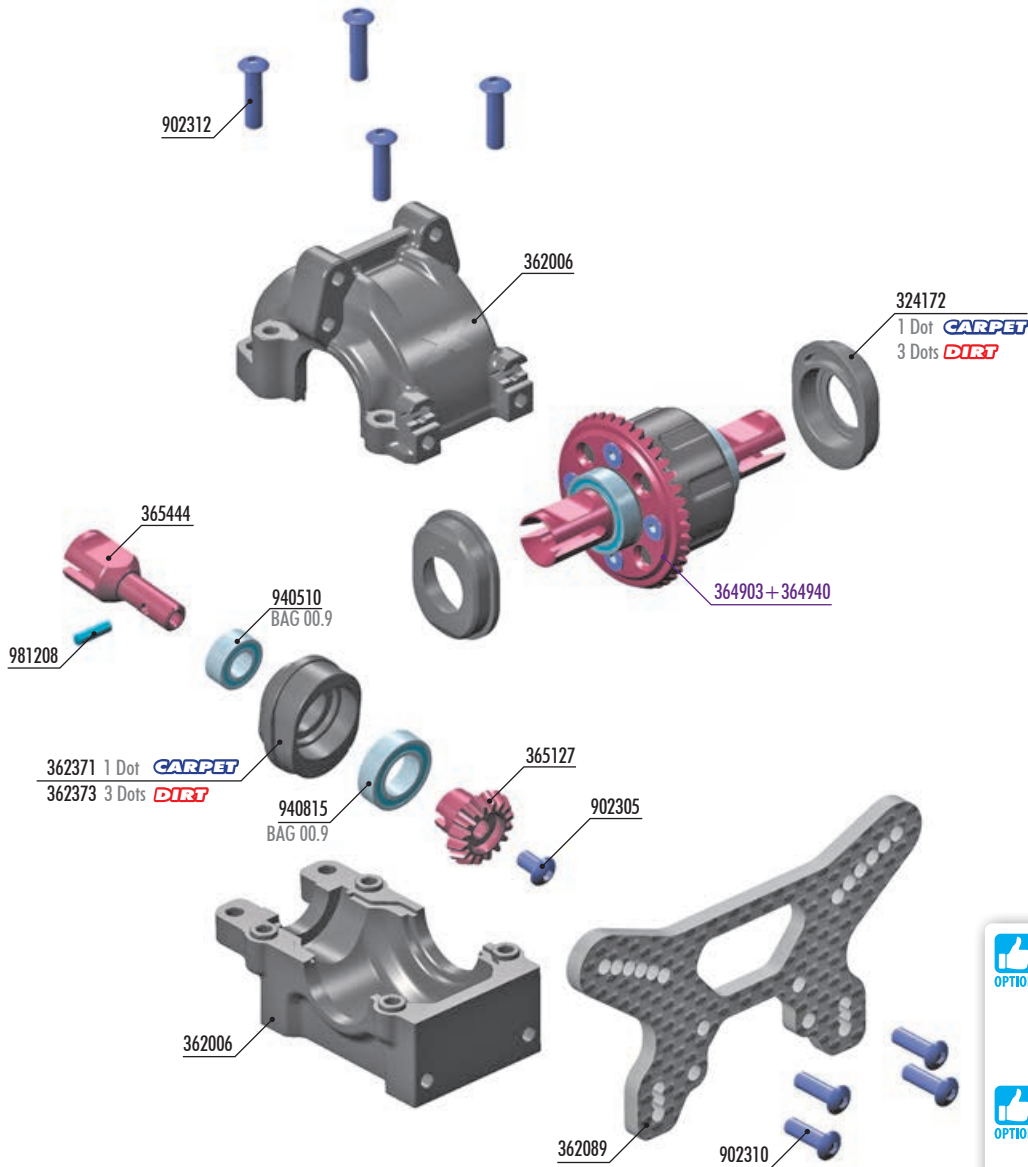

BALL-BEARING HUBS

#324172	1 DOT	INCLUDED	
#324172	2 DOTS	OPTION	
#324172	3 DOTS	INCLUDED	

ANGLE HUBS - FRONT

#362371	1 DOT	INCLUDED	
#362372	2 DOTS	OPTION	
#362373	3 DOTS	INCLUDED	

XRAY BALL-BEARINGS

#359050	5x10x4	GREASE	OPTION
#940510	5x10x4	OIL	INCLUDED
#940814	8x14x4	GREASE	OPTION
#940815	8x14x4	OIL	INCLUDED

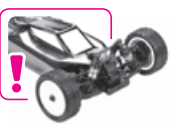

BAG
07

- 362006 DIFF BULKHEAD BLOCK SET
- 362089 CARBON SHOCK TOWER FOR HS BULKHEAD - 2-DOTS - FRONT
- 365127 STEEL BEVEL DRIVE GEAR - FOR HS BULKHEAD - CNC-MACHINED - 16T
- 365444 CENTRAL DOGBONE SHAFT UNIVERSAL JOINT - HUDY SPRING STEEL™
- 902305 HEX SCREW SH M3x5 (10)
- 902310 HEX SCREW SH M3x10 (10)
- 902312 HEX SCREW SH M3x12 (10)
- 940510 BALL-BEARING 5x10x4 RUBBER SEALED - OIL (2)
- 940815 BALL-BEARING 8x14x4 RUBBER SEALED - OIL (2)
- 981208 PIN 2x8 (10)

- 364903 GEAR DIFFERENTIAL - LARGE VOLUME - SET
- 364940 STEEL DIFFERENTIAL BEVEL GEAR FOR LARGE VOLUME DIFF 40T

- CARPET**
- 362371 ANGLED HUB FOR BEVEL DRIVE GEAR - FRONT HS BULKHEAD - 1 DOT
 - 324172 COMPOSITE ADJUSTMENT BALL-BEARING HUB - 1 DOT (2)
- DIRT**
- 362373 ANGLED HUB FOR BEVEL DRIVE GEAR - FRONT HS BULKHEAD - 3 DOTS
 - 324172 COMPOSITE ADJUSTMENT BALL-BEARING HUB - 3 DOTS (2)

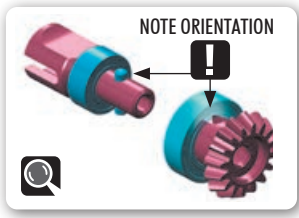
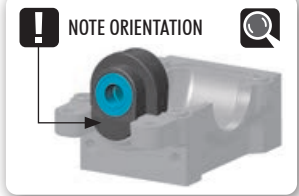
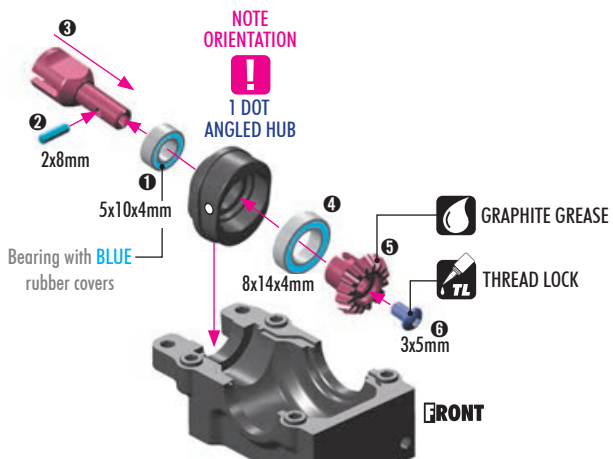
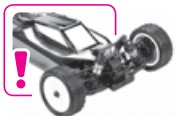

CARPET FRONT BEVEL DRIVE GEAR & DIFFERENTIAL HEIGHT ADJUSTMENT

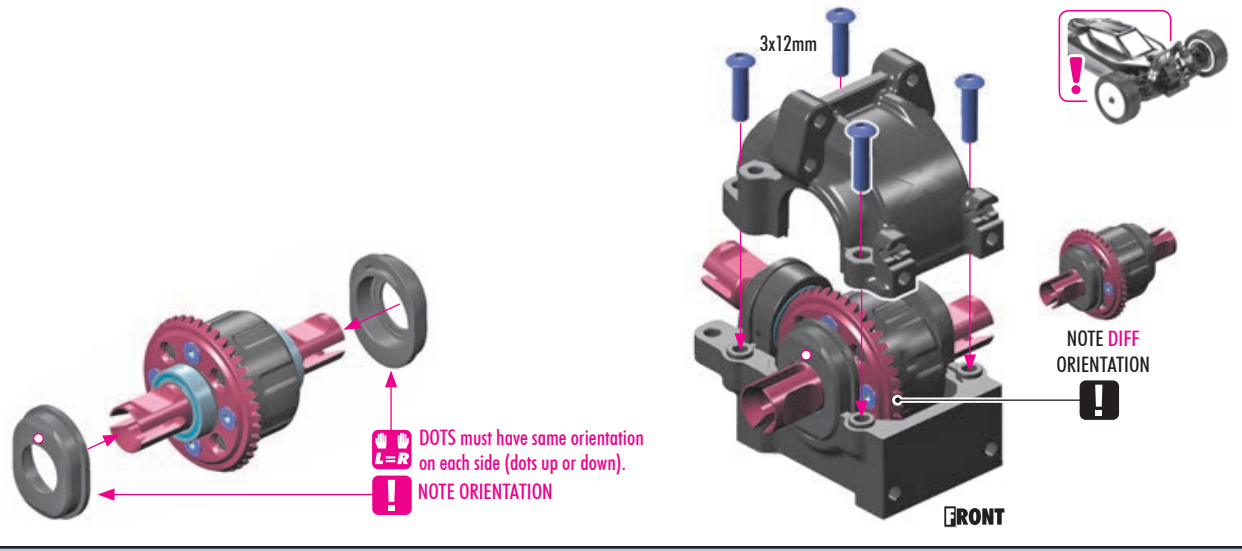
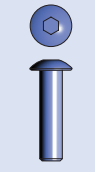
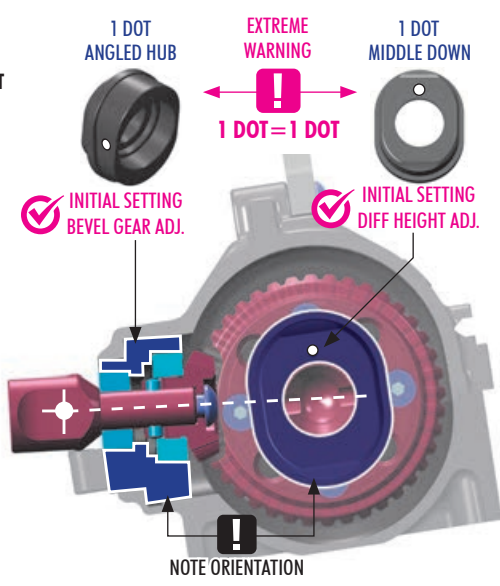

DOTS must have same orientation on each side (dots up or down).
NOTE ORIENTATION

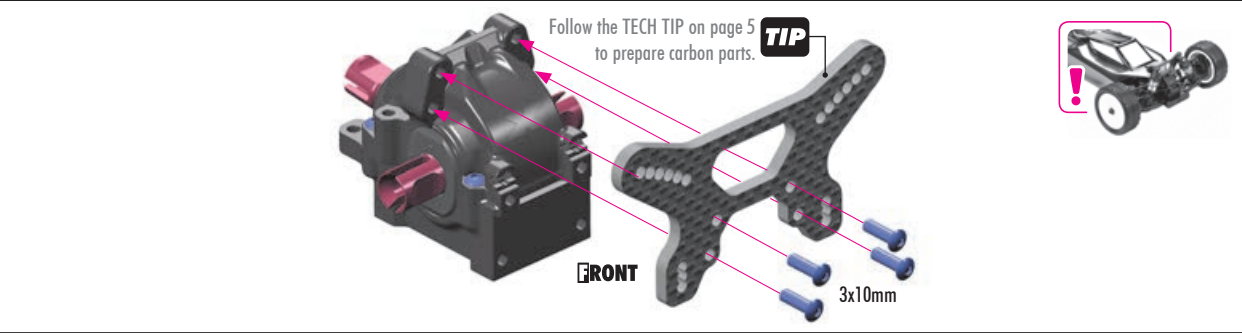
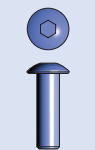

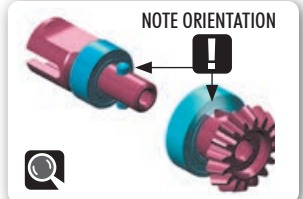
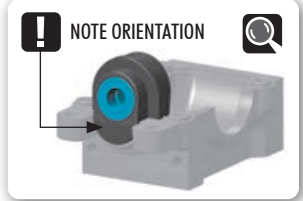
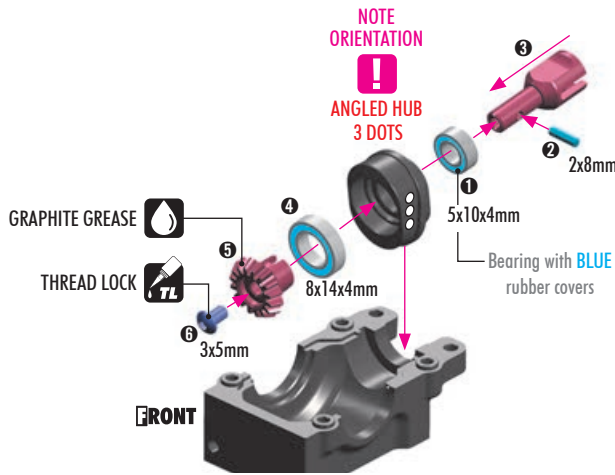
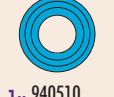
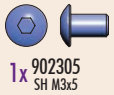

DIRT

FRONT BEVEL DRIVE GEAR & DIFFERENTIAL HEIGHT ADJUSTMENT

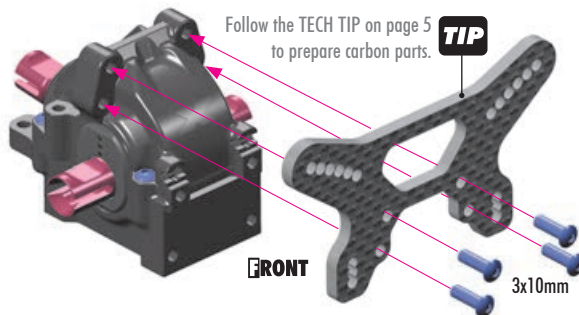
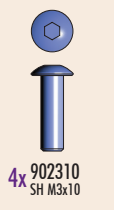
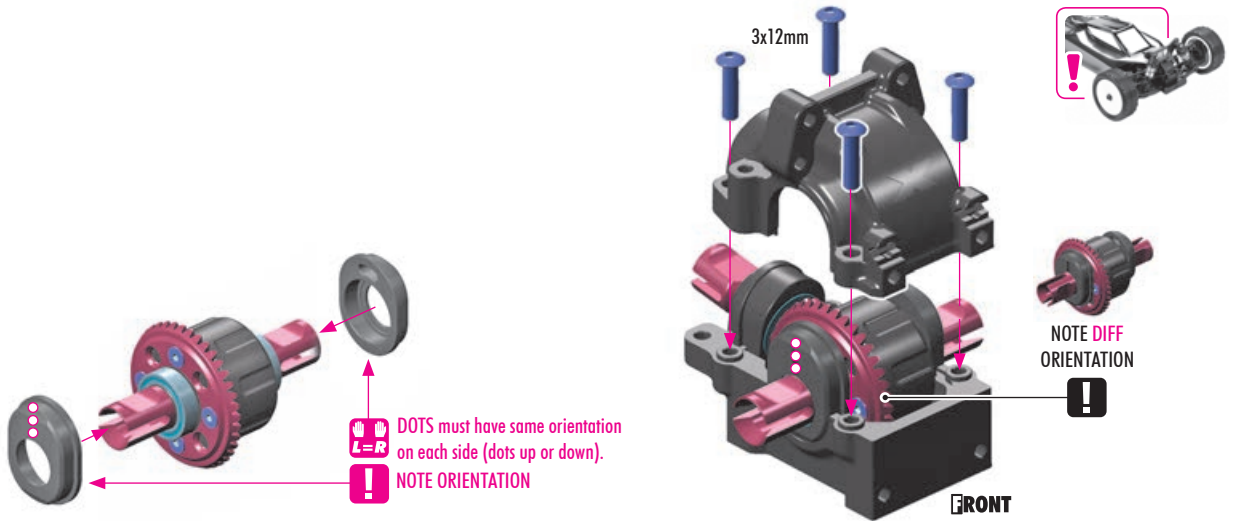
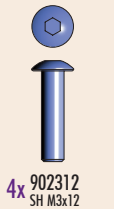
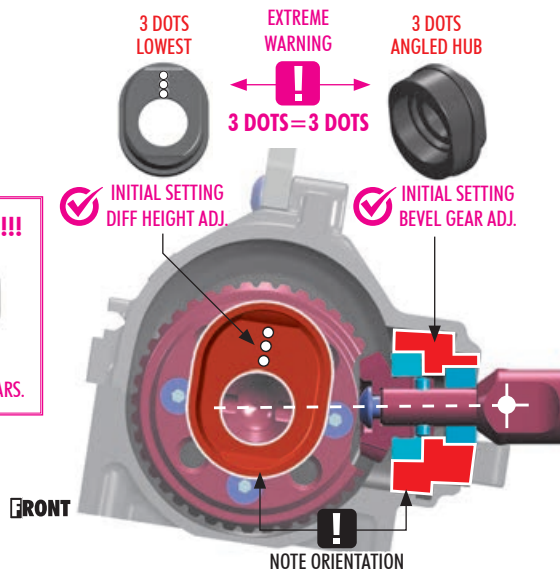

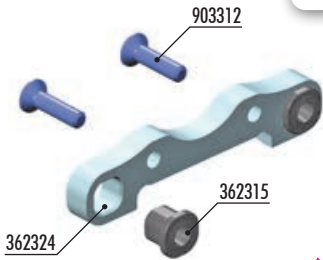
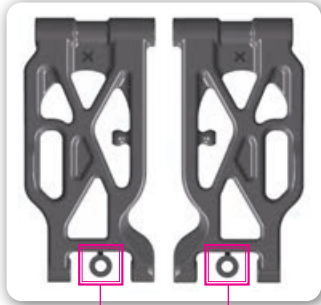
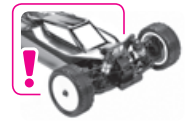

Remove the 2mm shim from each front arm.

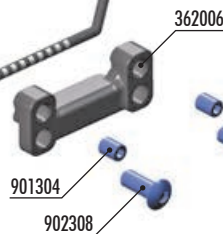
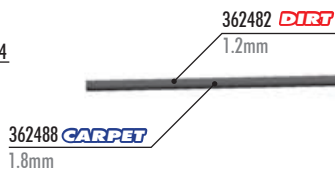
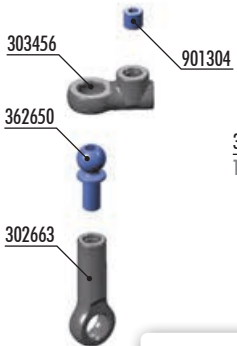
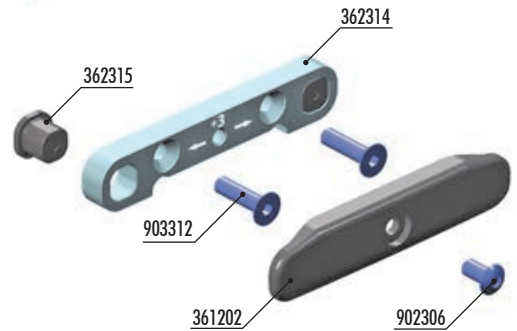
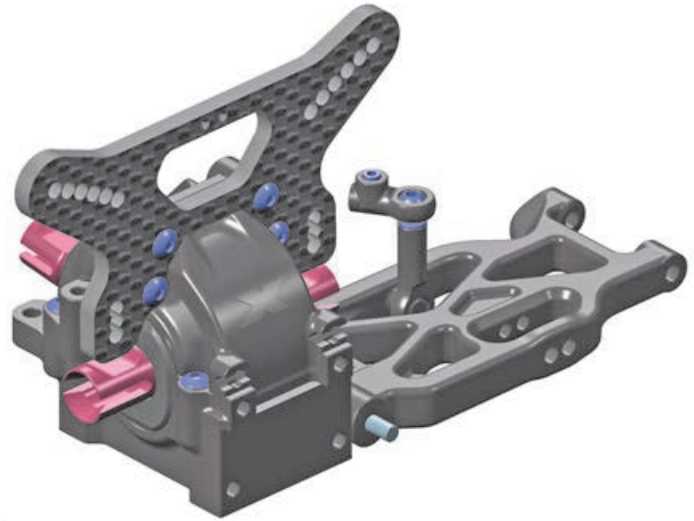

HUDY TITAN BALL ENDS
 #990006 6mm Thread **OPTION**

#362313
 ALU LOWER SUSPENS. HOLDER FOR HS BULKHEAD - FF **OPTION**

#362323
 ALU LOWER SUSPENSION HOLDER FOR HS BULKHEAD - FR **OPTION**

SHORT FRONT SUSPENSION ARMS				
#362112	MEDIUM	OPTION		
#362112-H	HARD	INCLUDED		
#362112-G	GRAPHITE	INCLUDED		
LONG FRONT SUSPENSION ARMS				
#362113-H	HARD	OPTION		
#362113-G	GRAPHITE	OPTION		

ANTI-ROLL BARS			
#362481	1.1mm	OPTION	
#362482	1.2mm	INCLUDED	
#362483	1.3mm	OPTION	
#362484	1.4mm	OPTION	
#362486	1.6mm	OPTION	
#362488	1.8mm	INCLUDED	
#362489	2.0mm	OPTION	



- 302663 COMPOSITE BALL JOINT 4.9mm - OPEN - V2 (8)
- 303456 COMPOSITE ANTI-ROLL BAR ø2.0mm BALL JOINT 4.9mm (4)
- 361202 COMPOSITE FRONT BUMPER ALIGNED WITH CHASSIS
- 362006 DIFF BULKHEAD - HORIZONTAL SPLIT DESIGN (HS) - FRONT/REAR - SET
- 362314 ALU LOWER SUSP. HOLDER WIDE FOR HS BULKHEAD - FRONT-FRONT
- 362315 ECCENTRIC BUSHING SET (2)
- 362324 ALU LOWER SUSP. HOLDER WIDE FOR HS BULKHEAD - FRONT-REAR
- 362650 BALL END 4.9MM WITH THREAD 6mm (2)
- 367210 SUSPENSION PIVOT PIN (2)
- 901304 HEX SCREW SB M3x4 (10)
- 902306 HEX SCREW SH M3x6 (10)

- 902308 HEX SCREW SH M3x8 (10)
- 903312 HEX SCREW SFH M3x12 (10)
- DIRT**
- 362482 ANTI-ROLL BAR 1.2mm
- 362112-H COMPOSITE SUSPENSION ARM FRONT LOWER - HARD
- CARPET**
- 362488 ANTI-ROLL BAR 1.8mm
- 362112-G COMPOSITE SUSPENSION ARM FRONT LOWER - GRAPHITE

- 10**
- 2x From Front Arm SHIM 3x6.5x2
- 4x 903312 SFH M3x12

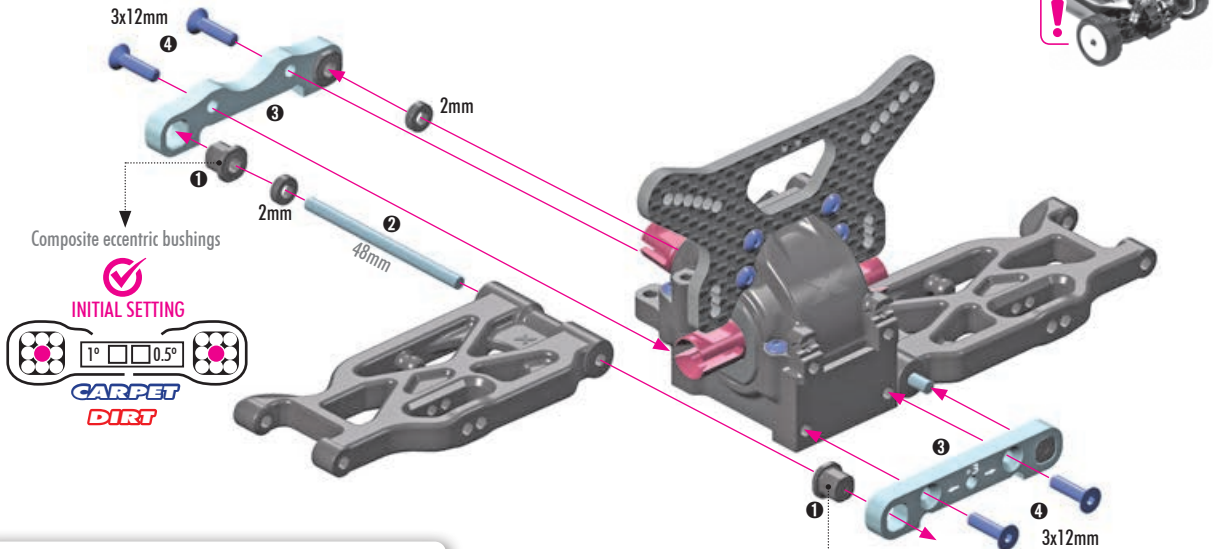

TIP **L=R**

If the suspension arm DOES NOT move freely use a HUDY Arm Reamer to size the holes of the arms.

Arm Reamer 3.0mm (HUDY #107643)

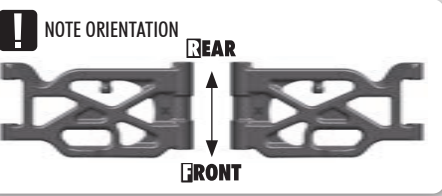

#362313 **ALU LOWER SUSPENS. HOLDER FOR HS BULKHEAD - FF**

#362323 **ALU LOWER SUSPENSION HOLDER FOR HS BULKHEAD - FR**

CHECK FOR FREE MOVEMENT

OPTION	SHORT FRONT SUSPENSION ARMS			
#362112	MEDIUM	OPTION		
#362112-H	HARD	INCLUDED		
#362112-G	GRAPHITE	INCLUDED		
OPTION	LONG FRONT SUSPENSION ARMS			
#362113-H	HARD	OPTION		
#362113-G	GRAPHITE	OPTION		

ECCENTRIC BUSHINGS HAVE TWO DIFFERENT OFFSETS FROM THE CENTER.



The XRAY alu front lower suspension holders provide great range of adjustment for the front suspension. Using different combinations of eccentric bushings, fine adjustment of front kick-up, roll-center, and front track-width can be obtained. For more information about the influence of kick-up, front track-width, and roll centers on car handling, please refer to HUDY Set-up Book (#209100).

KICK-UP			(°)
FF	FR		
			=7°
			=6°
			=8°
			=6°
			=5°
			=7°
			=8°
			=7°
			=9°

ROLL CENTER			(mm)
FF	FR		
			=+0.75mm
			= 0mm
			=-0.75mm

TRACK-WIDTH			(mm)
FF	FR		
			=+1.5mm
			= 0mm
			=-1.5mm

The tables describe the amounts of adjustment using the center and outside positions of the eccentric bushings. The middle position eccentric bushings allow for finer adjustment increments.

The track-width is directly influenced by the size of the wheels and tires used.

TOTAL CASTER=C-HUB CASTER+KICK-UP						
C-HUB CASTER	KICK-UP					
	6°	7°	8°	9°	10°	
6°	12°	13°	14°	15°	16°	
9°	15°	16°	17°	18°	19°	

Caster is the angle between the steering pivot axis and the vertical plane. Caster is affected not only by the C-Hub caster, but also by the front kick-up angle relative to the flat chassis bottom. The table indicates how kick up angle effects total caster.

The XB4's stock caster blocks are 9°, but 6° blocks are available as an option.

8. FRONT SUSPENSION

CARPET

DIRT

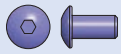

1x 902306
SH M3x6

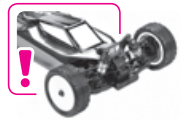
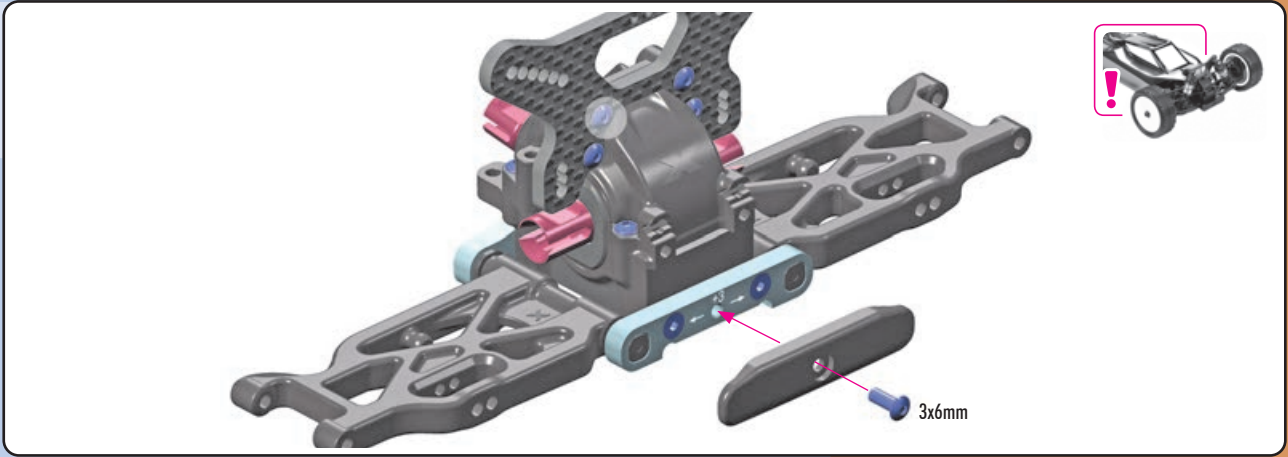

2x LEFT = RIGHT

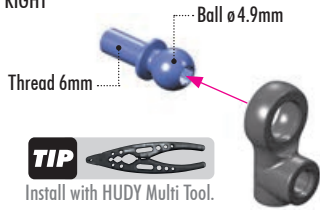

HUDY TITAN BALL ENDS
OPTION #990006 6mm Thread OPTION

2x LEFT = RIGHT

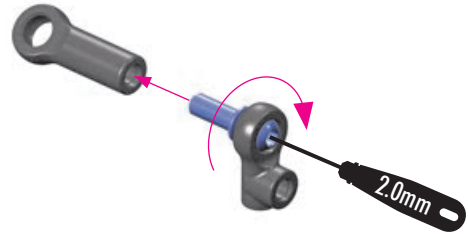

2x 901304
SB M3x4

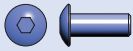

2x 902308
SH M3x8

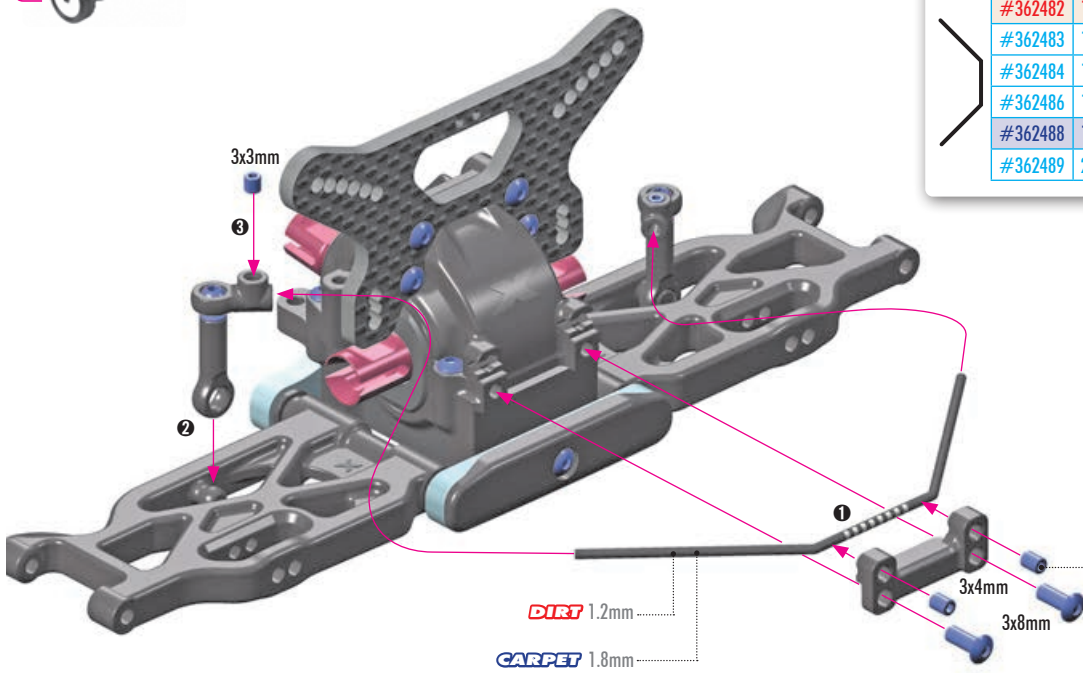

ANTI-ROLL BARS			
OPTION	#362481	1.1mm	OPTION
	#362482	1.2mm	INCLUDED
	#362483	1.3mm	OPTION
	#362484	1.4mm	OPTION
	#362486	1.6mm	OPTION
	#362488	1.8mm	INCLUDED
	#362489	2.0mm	OPTION

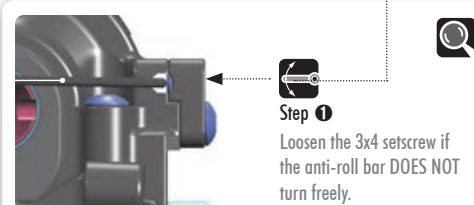

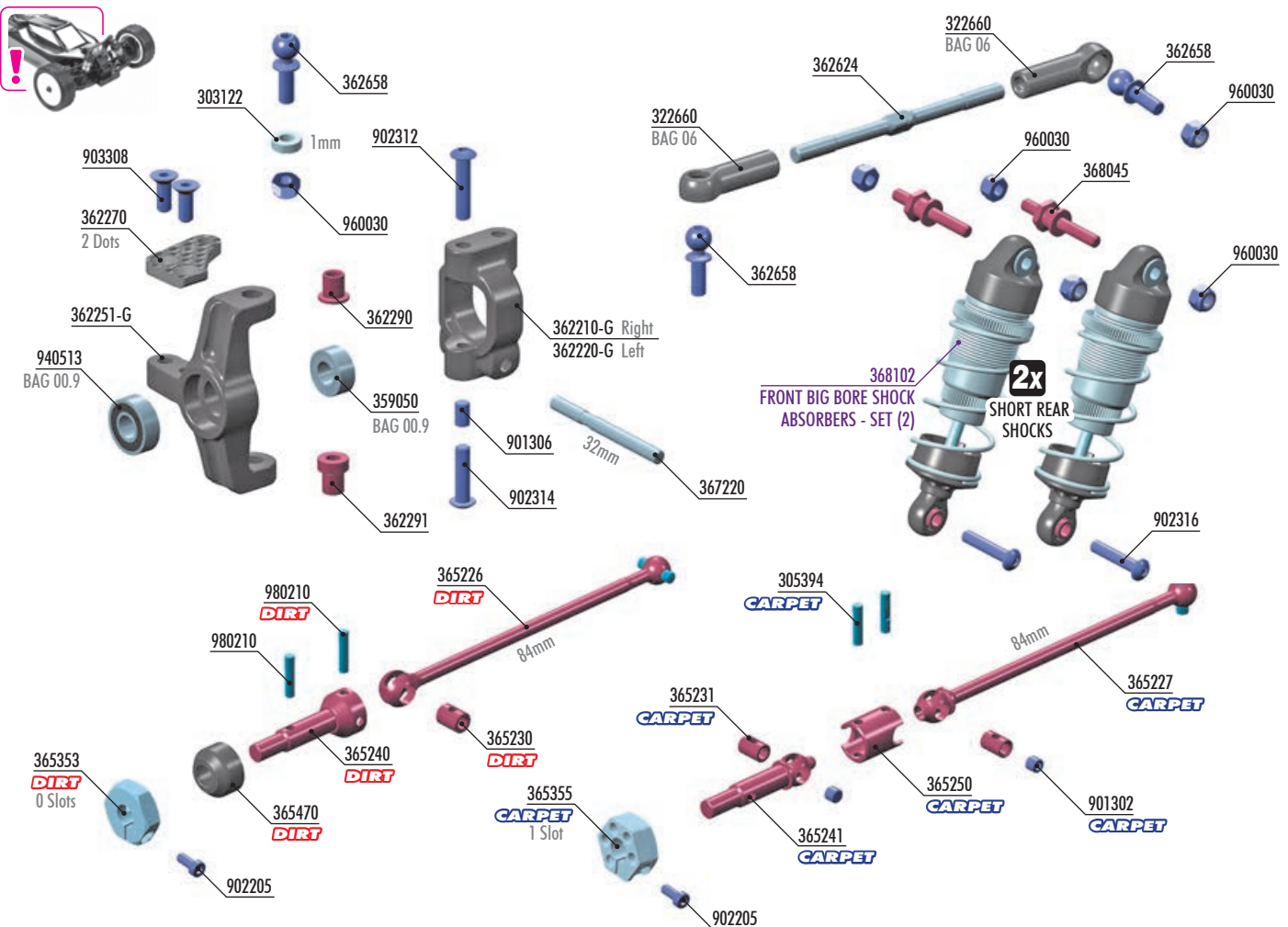

STEERING BLOCK EXTENSIONS

#322274	1 DOT	OPTION
#362270	2 DOTS	INCLUDED
#322275	3 DOTS	OPTION

Steering angle of the outside wheel.

#360900 ALU STEERING BLOCKS & 7° C-HUBS - SET



- 303122 ALU SHIM 3x6x1.0MM (10)
- 322660 COMPOSITE BALL JOINT 5.4mm (12+1+1)
- 362210-G COMPOSITE C-HUB 9° DEG. RIGHT - GRAPHITE
- 362220-G COMPOSITE C-HUB 9° DEG. LEFT - GRAPHITE
- 362251-G COMPOSITE STEERING BLOCK - GRAPHITE
- 362270 CARBON EXTENSION FOR ALU STEERING BLOCK (1+1) - 2 DOTS
- 362290 STEEL STEERING BUSHING - SHORT (2)
- 362291 STEEL STEERING BUSHING - LONG (2)
- 362624 ADJUSTABLE TURNBUCKLE 50mm M3.5 L/R - HUDY SPRING STEEL™ (2)
- 362658 HARD STEEL BALL END 5.4mm WITH THREAD 8mm - NICKEL COATED (2)
- 367220 FRONT ARM PIVOT PIN (2)
- 368045 STEEL SCREW SHOCK PIVOT BALL WITH HEX (2)
- 359050 BALL-BEARING 5x10x4 STEEL SEALED - GREASE (2)
- 901306 HEX SCREW SB M3x6 (10)
- 902205 HEX SCREW SH M2x5 (10)
- 902312 HEX SCREW SH M3x12 (10)
- 902314 HEX SCREW SH M3x14 (10)
- 902316 HEX SCREW SH M3x16 (10)
- 903308 HEX SCREW SFH M3x8 (10)

- 940513 BALL-BEARING 5x12x4 RUBBER SEALED - GREASE (2)
- 960030 NUT M3 (10)
- 980210 PIN 2x10 (10)
- CARPET**
- 365227 ECS DRIVE SHAFT 84mm WITH 2.5mm PIN - HUDY SPRING STEEL™
- 365231 ECS DRIVE SHAFT COUPLING - HUDY SPRING STEEL™
- 365241 FRONT ECS DRIVE AXLE - HUDY SPRING STEEL™
- 365250 ECS DRIVE SHAFT CASE - HUDY SPRING STEEL™
- 365355 ALU WHEEL HUB 12mm - OFFSET "+0.75mm" (2)
- 305394 ECS DRIVE SHAFT PIN 2 x 9 WITH FLAT SPOT (2)
- 901302 HEX SCREW SB M3x2.5 (10)
- DIRT**
- 365226 FRONT DRIVE SHAFT 84mm WITH 2.5mm PIN - HUDY SPRING STEEL™
- 365230 DRIVE SHAFT COUPLING - HUDY SPRING STEEL™
- 365240 FRONT DRIVE AXLE - HUDY SPRING STEEL™
- 365353 ALU WHEEL HUB 12MM - 0mm (2)
- 365470 COMPOSITE DRIVE SHAFT SAFETY COLLAR (3)
- 368102 FRONT SHOCK ABSORBERS 30mm - BIG BORE - SET (2)

2x 980210
P 2x10

- 2x** LEFT = RIGHT
- 1 2 3** SPECIFIC ORDER STEPS

Steps only for **DIRT** Edition

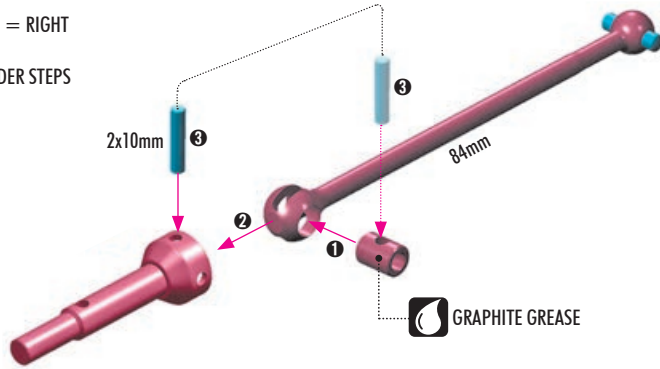

EXTREMELY IMPORTANT

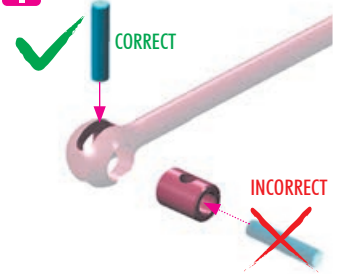

2x 303122 SHIM 3x6x1

4x 903308 SFH M3x8

2x 359050 BB 5x10x4

2x 940513 BB 5x12x4

- 2x** L=R

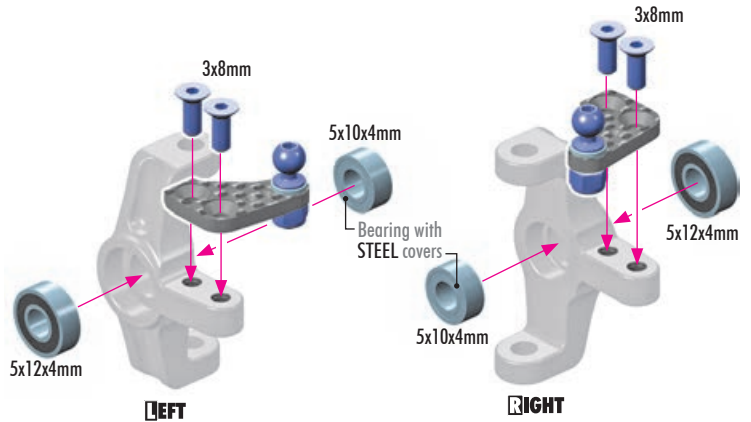
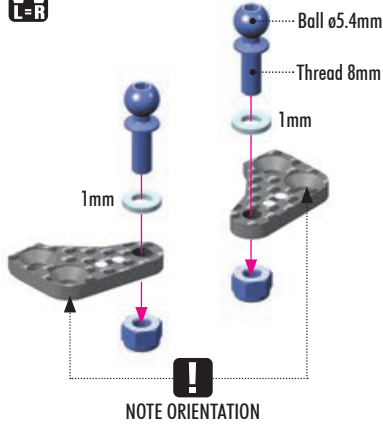

2x 902205 SH M2x5

2x 980210 P 2x10

- 2x** L=R

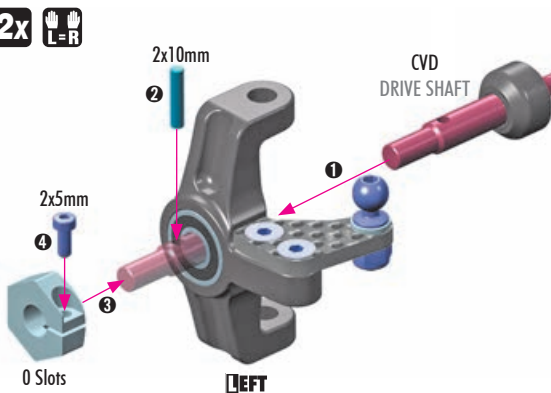

OPTION	WHEEL HUBS 12MM	OPTION
	#365360 +4.5mm - 6 SLOTS	OPTION
	#365359 +3.75mm - 5 SLOTS	OPTION
	#365358 +3.0mm - 4 SLOTS	OPTION
	#365357 +2.25mm - 3 SLOTS	OPTION
	#365356 +1.5mm - 2 SLOTS	OPTION
	#365355 +0.75mm - 1 SLOT	OPTION
	#365353 0mm - 0 SLOTS	INCLUDED
	#365354 -0.75mm - Lightw.	OPTION
	#365361 -1.25mm - Lightw.	OPTION

OPTIONAL HEX HUB EFFECTS

Different off-set hex hubs are used to increase or decrease the track-width.

LESS OFF-SET

Rear - more traction
Front - more steering

MORE OFF-SET

Rear - less traction
Front - less steering

2x 902312 SH M3x12

2x 902314 SH M3x14

- 2x** L=R

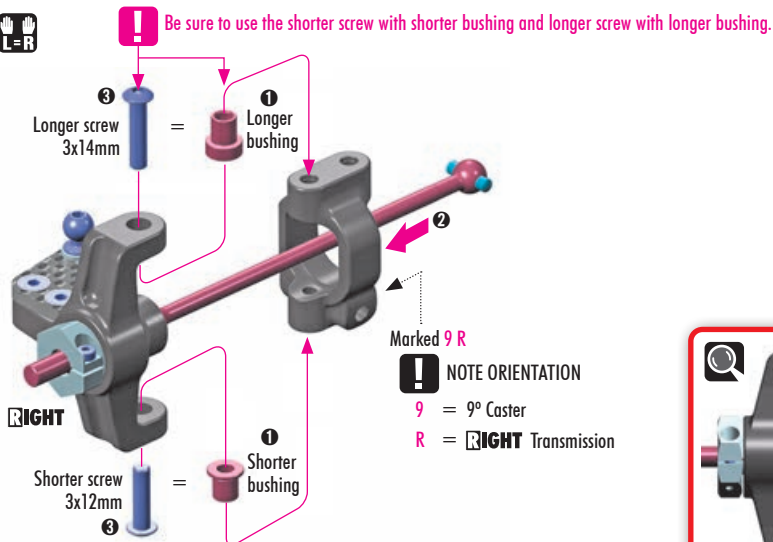

Marked **9 R**

NOTE ORIENTATION

9 = 9° Caster
R = **RIGHT** Transmission

NOTE ORIENTATION
When inserting the bushings, make sure that bushings are inserted equally on both **RIGHT** and **LEFT** hub to give the same roll center position.

OPTION #360900 ALU STEER. BLOCKS & 7° C-HUBS - SET

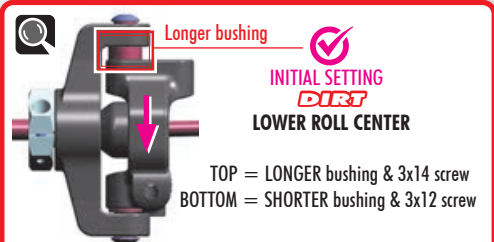

- 4x 901302 SB M3x2.5
- 4x 305394 P 2x9

2x

Steps only for **CARPET Edition**

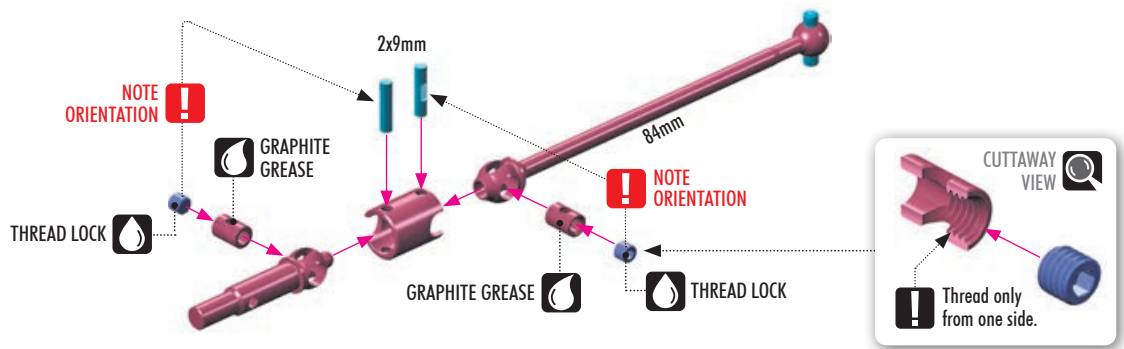

- 2x 303122 SHIM 3x6x1
- 4x 903308 SFH M3x8
- 2x 359050 BB 5x10x4
- 2x 940513 BB 5x12x4

2x

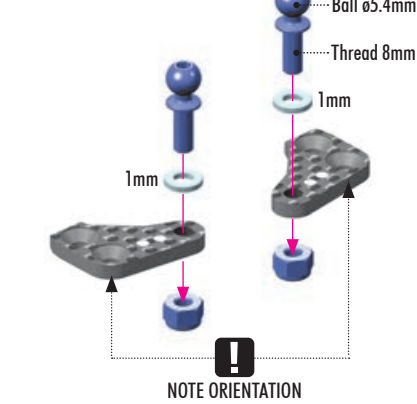

2x

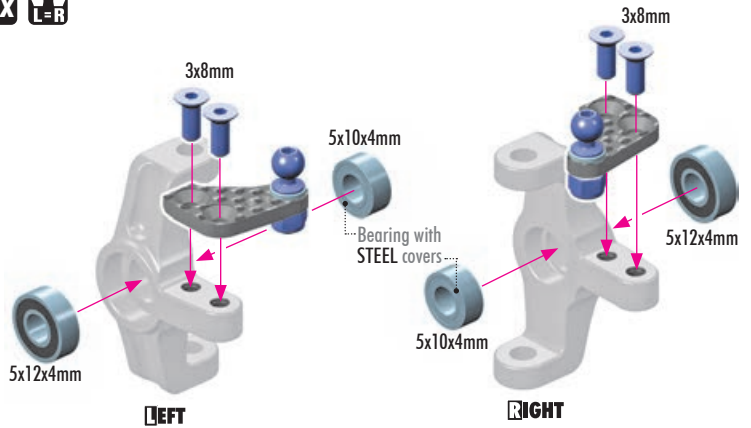

- 2x 902205 SH M2x5
- 2x 980210 P 2x10

2x

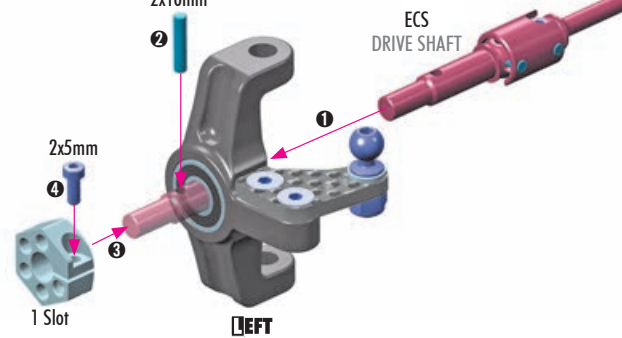

OPTION	WHEEL HUBS 12MM	OPTION	OPTIONAL HEX HUB EFFECTS
#365360	+4.5mm 6 SLOTS	OPTION	Different off-set hex hubs are used to increase or decrease the track-width.
#365359	+3.75mm 5 SLOTS	OPTION	
#365358	+3.0mm 4 SLOTS	OPTION	
#365357	+2.25mm 3 SLOTS	OPTION	
#365356	+1.5mm 2 SLOTS	INCLUDED	LESS OFF-SET Rear - more traction Front - more steering
#365355	+0.75mm 1 SLOT	INCLUDED	
#365353	0mm 0 SLOTS	OPTION	MORE OFF-SET Rear - less traction Front - less steering
#365354	-0.75mm	Lightw. OPTION	
#365361	-1.25mm	Lightw. OPTION	

- 2x 902312 SH M3x12
- 2x 902314 SH M3x14

2x

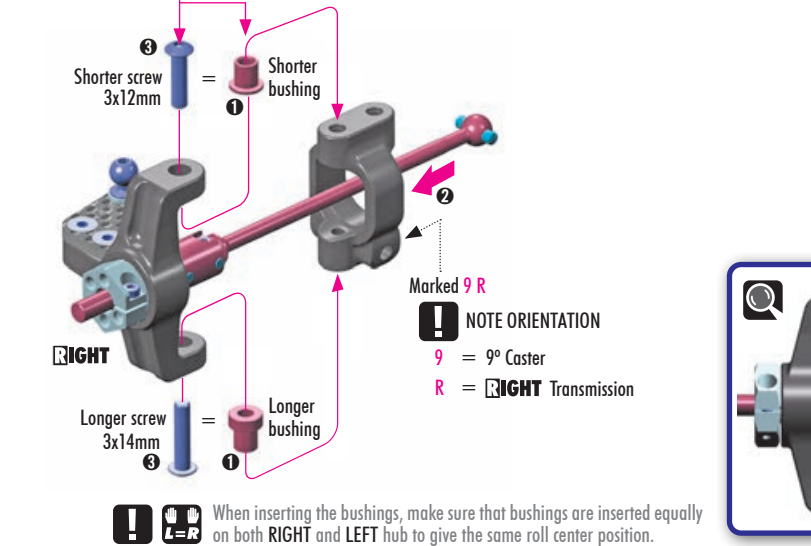

#360900 ALU STEER. BLOCKS & 7° C-HUBS - SET

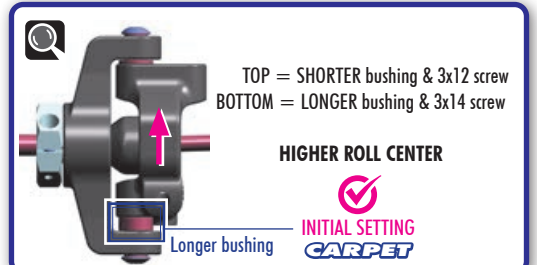

2x 901306
SB M3x6

2x LEFT = RIGHT

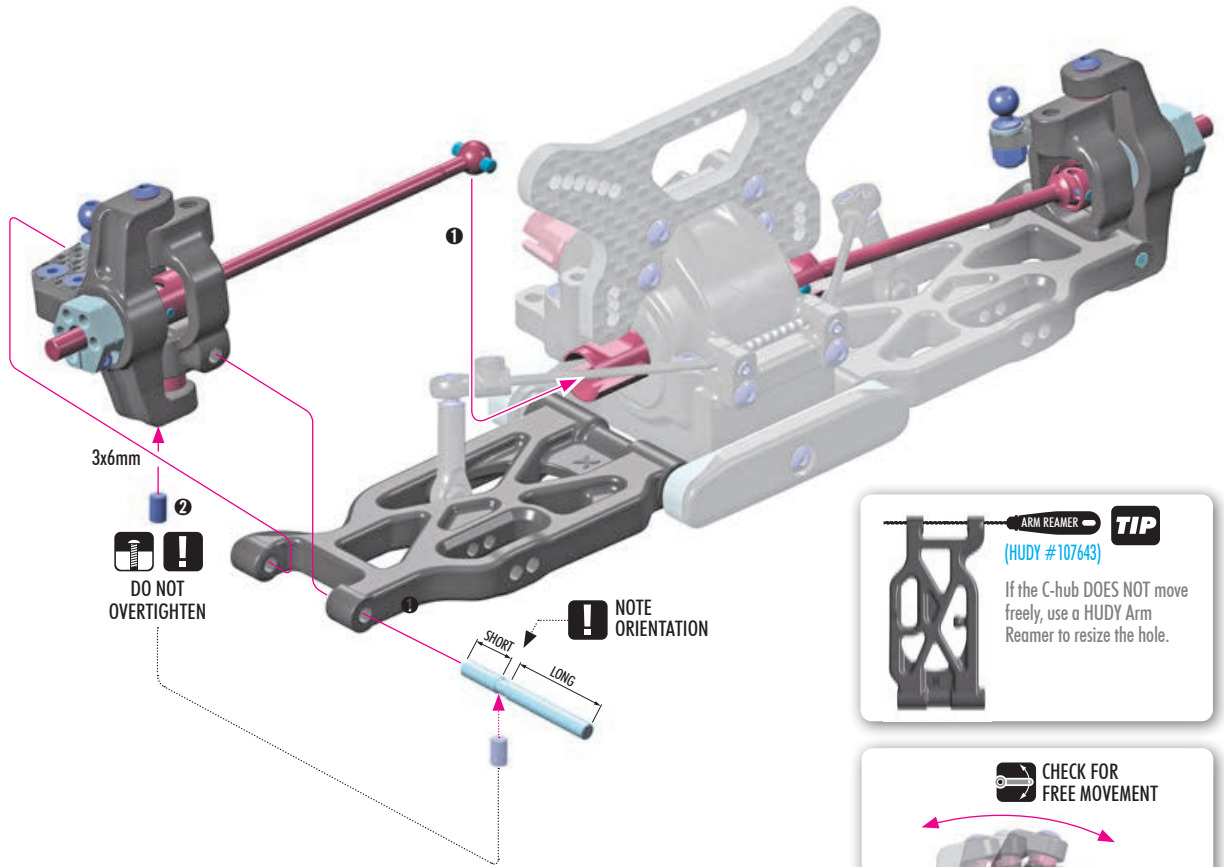

ARM REAMER (HUDY #107643) **TIP**

If the C-hub DOES NOT move freely, use a HUDY Arm Reamer to resize the hole.

CHECK FOR FREE MOVEMENT

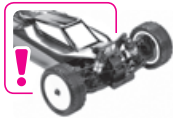

ROLL CENTER LINKS

2x LEFT = RIGHT

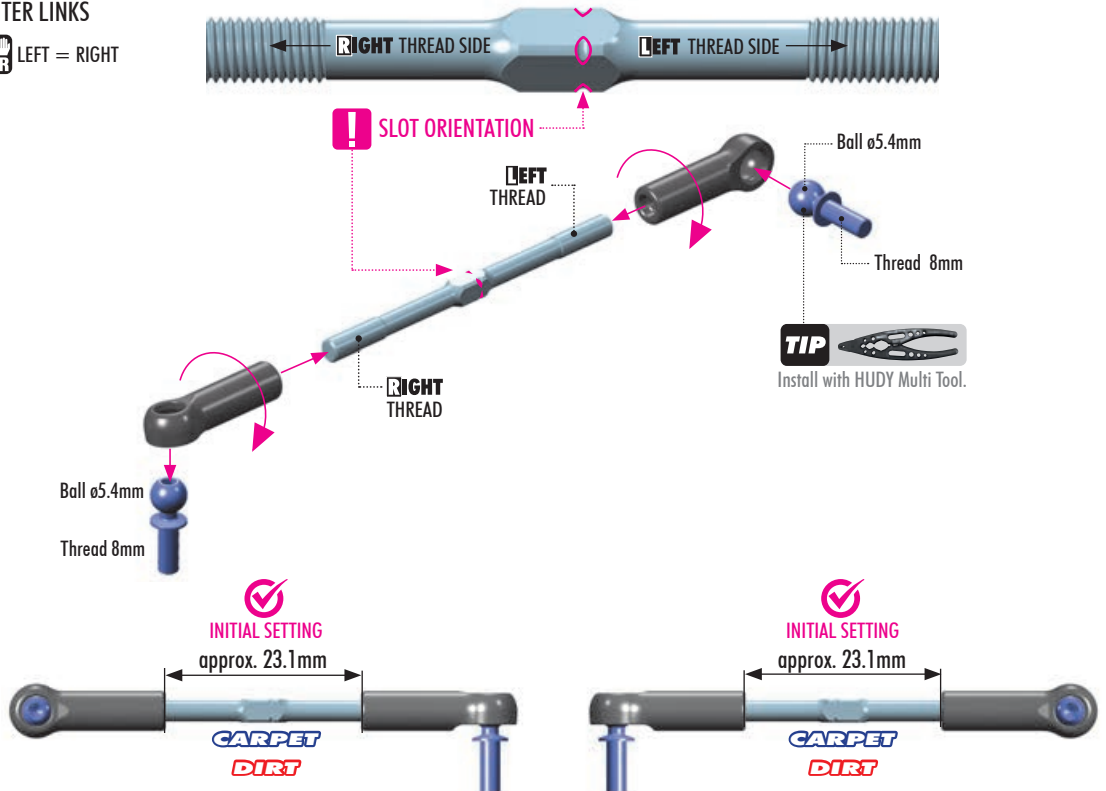



2x 960030 N M3

2x LEFT = RIGHT

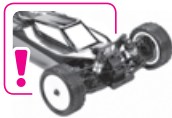
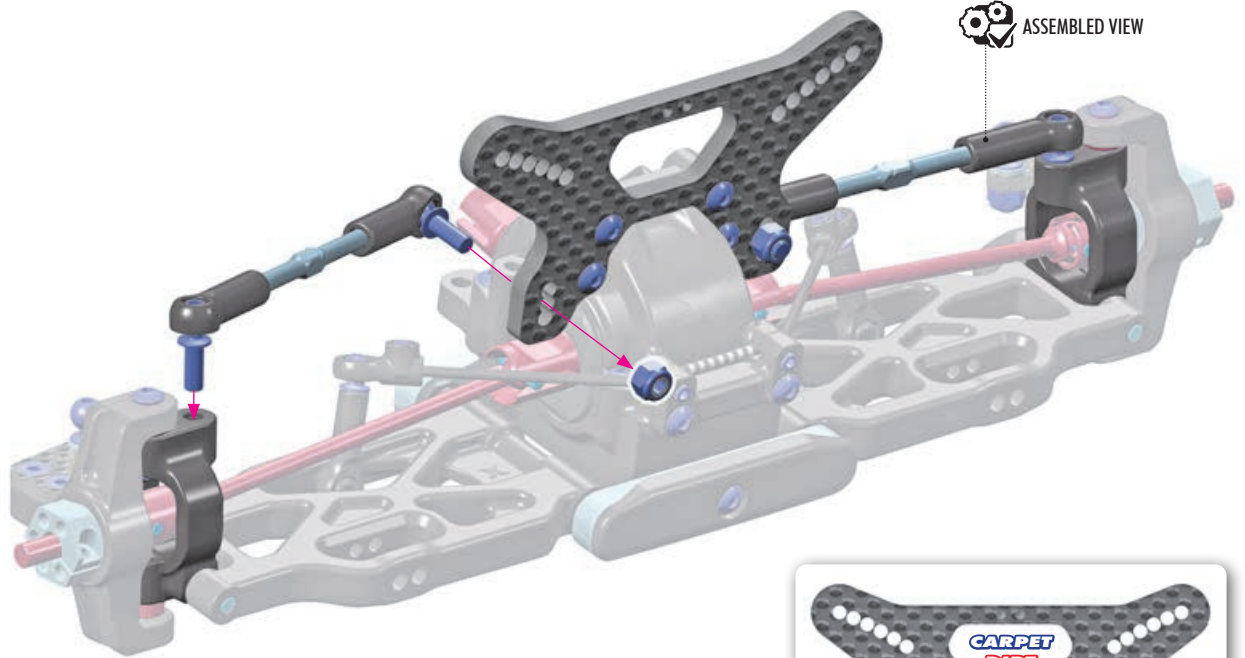

2x 902316 SH M3x16



4x 960030 N M3

2x LEFT = RIGHT

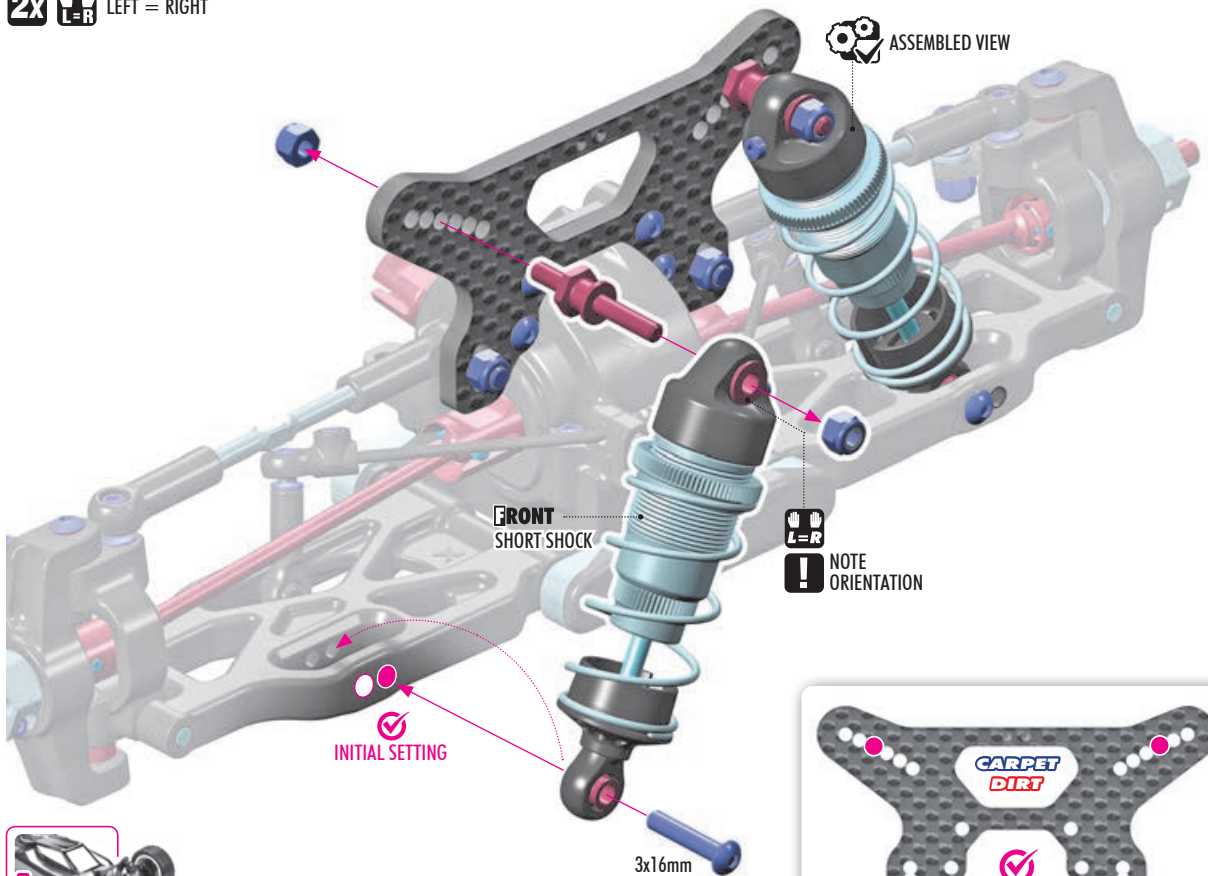

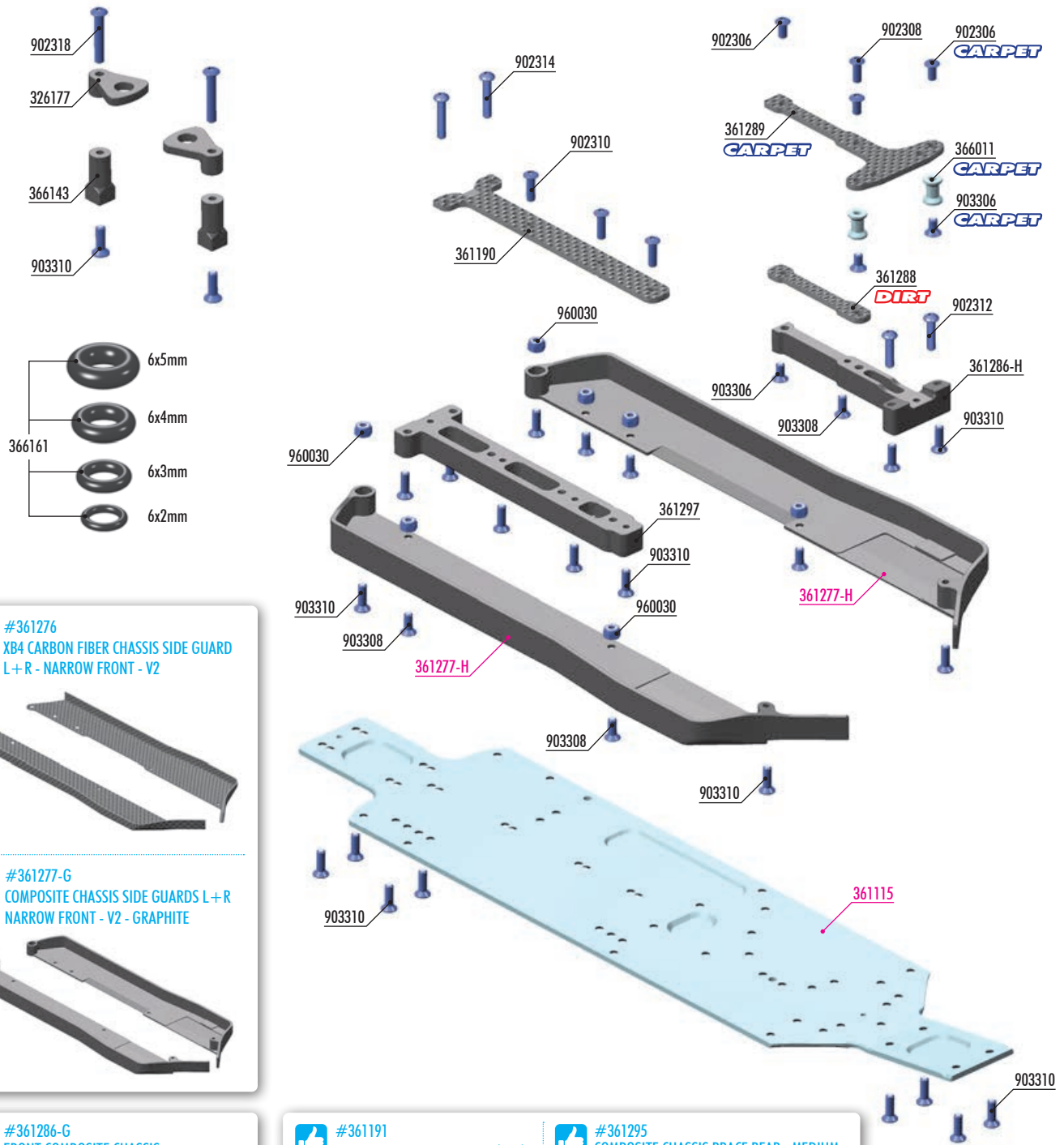

#361276
OPTION
 XB4 CARBON FIBER CHASSIS SIDE GUARD
 L+R - NARROW FRONT - V2



#361277-G
OPTION
 COMPOSITE CHASSIS SIDE GUARDS L+R
 NARROW FRONT - V2 - GRAPHITE



#361286-G
OPTION
 FRONT COMPOSITE CHASSIS
 BRACE - GRAPHITE



#361191
OPTION
 BRASS CHASSIS BRACE REAR (40g)



#361295
OPTION
 COMPOSITE CHASSIS BRACE REAR - MEDIUM



#361297-G
OPTION
 COMPOSITE CHASSIS BRACE REAR - GRAPHITE

BAG
10

326177 COMPOSITE BATTERY CLAMP (2)
 361190 CARBON CHASSIS BRACE UPPER DECK 2.2mm
 361286-H COMPOSITE CHASSIS BRACE FRONT - HARD
 361297 COMPOSITE CHASSIS BRACE REAR - HARD
 366143 COMPOSITE BATTERY HOLDER STAND (2)

366161 SET OF O-RINGS (6x2, 6x3, 6x4, 6x5mm)
 902306 HEX SCREW SH M3x6 (10)
 902308 HEX SCREW SH M3x8 (10)
 902310 HEX SCREW SH M3x10 (10)
 902312 HEX SCREW SH M3x12 (10)
 902314 HEX SCREW SH M3x14 (10)
 902318 HEX SCREW SH M3x18 (10)

903306 HEX SCREW SFH M3x6 (10)
 903308 HEX SCREW SFH M3x8 (10)
 903310 HEX SCREW SFH M3x10 (10)
 960030 NUT M3 (10)

CARPET
 361289 CARBON CHASSIS T-BRACE - FRONT - 2.2mm
 366011 ALU BRACE MOUNT - SWISS 7075 T6 (2)

DIRT
 361288 CARBON CHASSIS WIRE COVER 2.2mm

361115 ALU CHASSIS 2mm FOR LOW PROFILE BUMPER - SWISS 7075 T6
 361277-H COMPOSITE CHASSIS SIDE GUARDS L+R - NARROW FRONT - V2

-  4x 903308 SFH M3x8
-  4x 903310 SFH M3x10
-  6x 960030 N M3

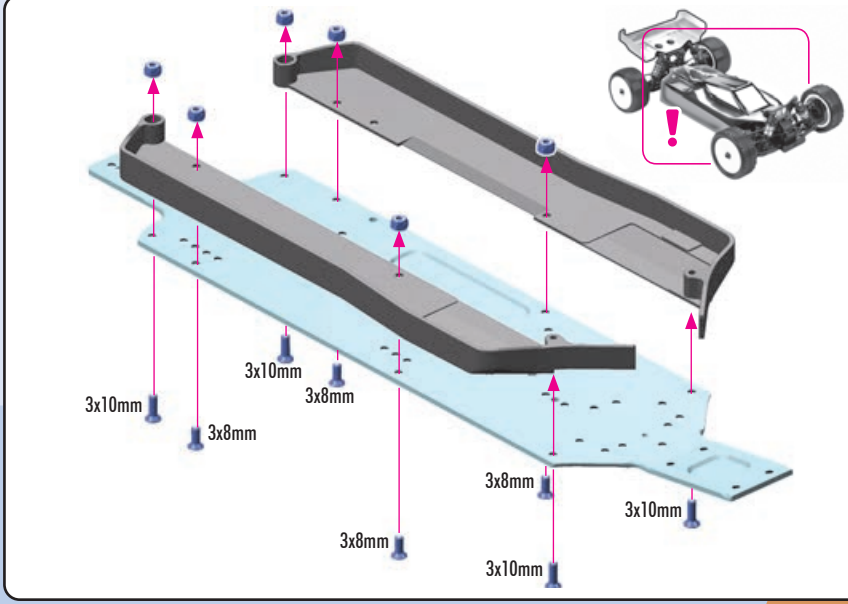

 #361276
XB4 CARBON FIBER CHASSIS SIDE GUARD
L+R - NARROW FRONT - V2



 #361277-G
COMPOSITE CHASSIS SIDE GUARDS L+R
NARROW FRONT - V2 - GRAPHITE



-  3x 902310 SH M3x10
-  1x 903306 SFH M3x6
-  6x 903310 SFH M3x10

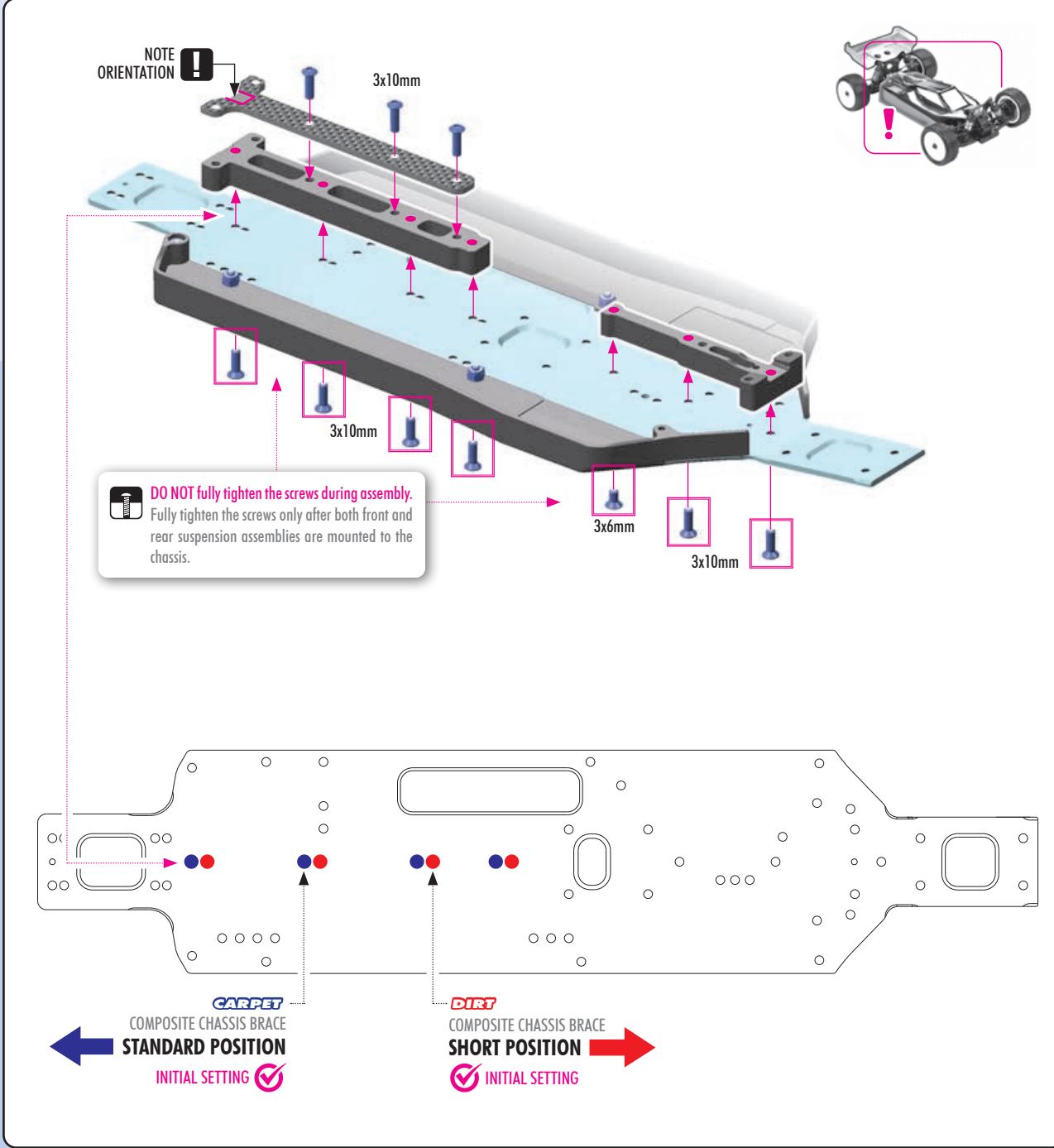

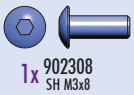
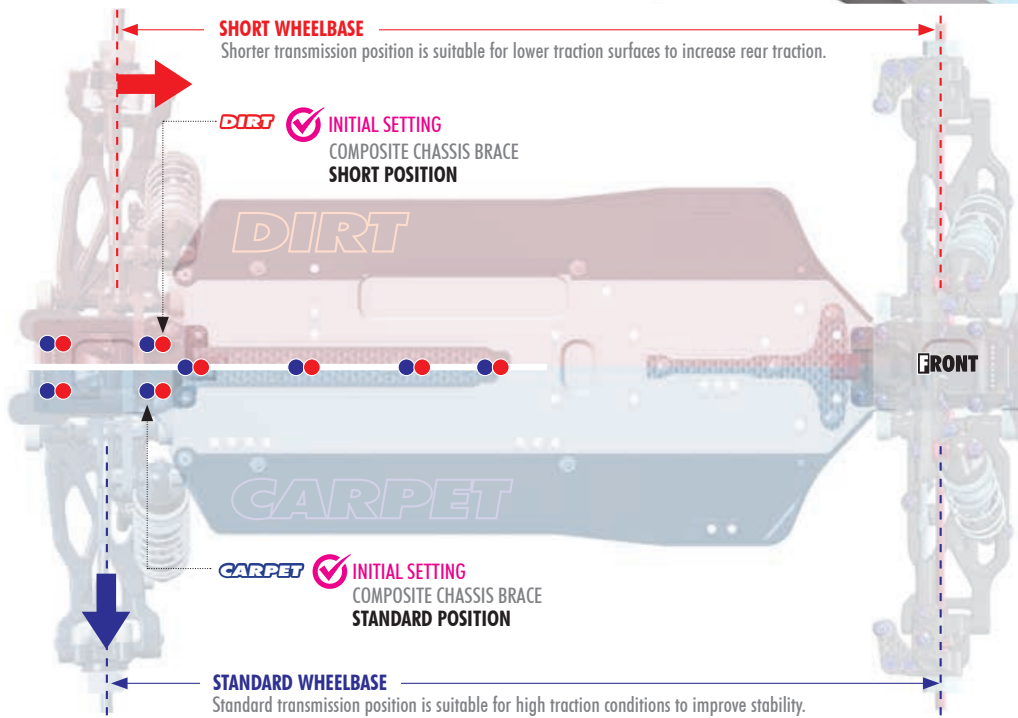
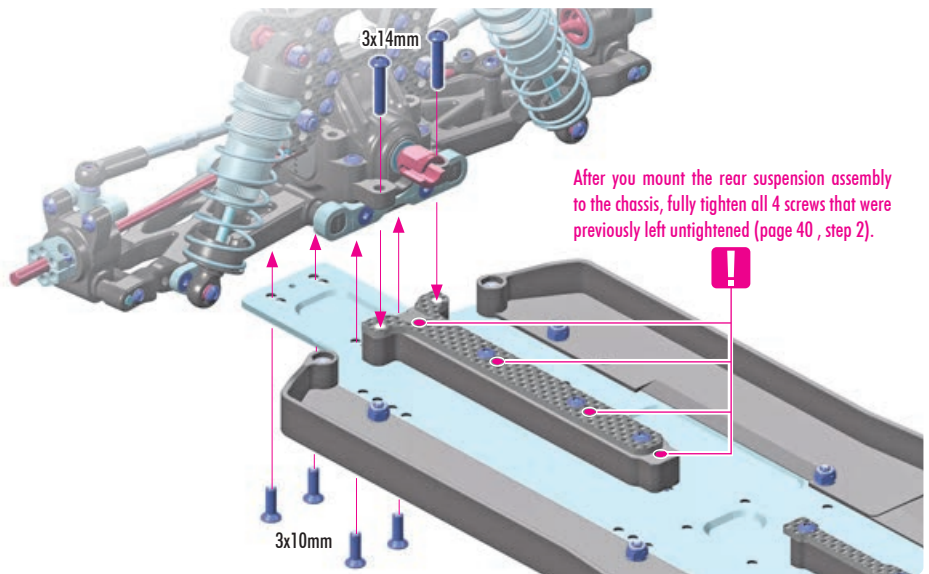

Steps only for **CARPET** Edition

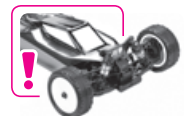
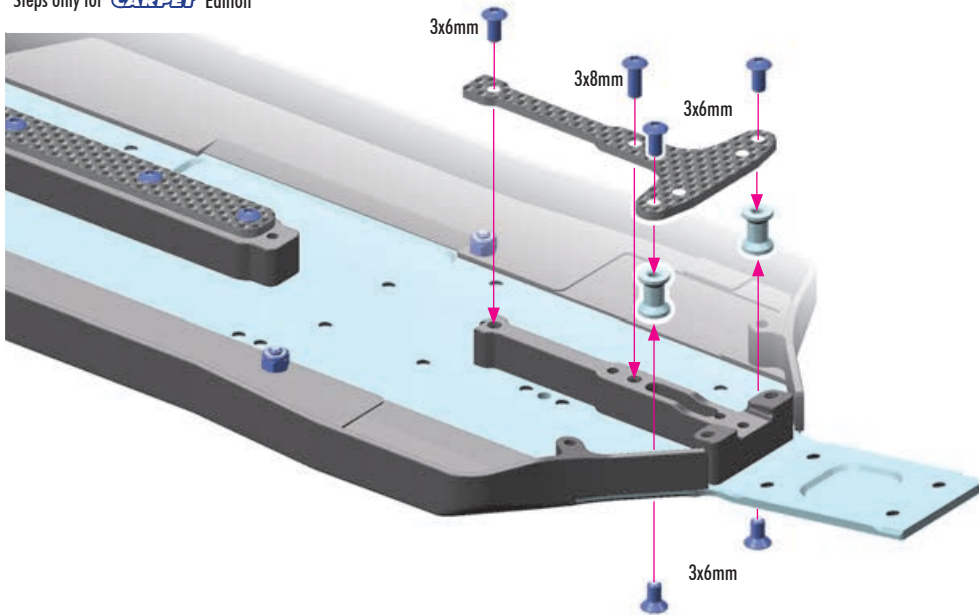



1x 902306 SH M3x6

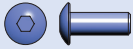

1x 902308 SH M3x8

Steps only for **DIRT** Edition

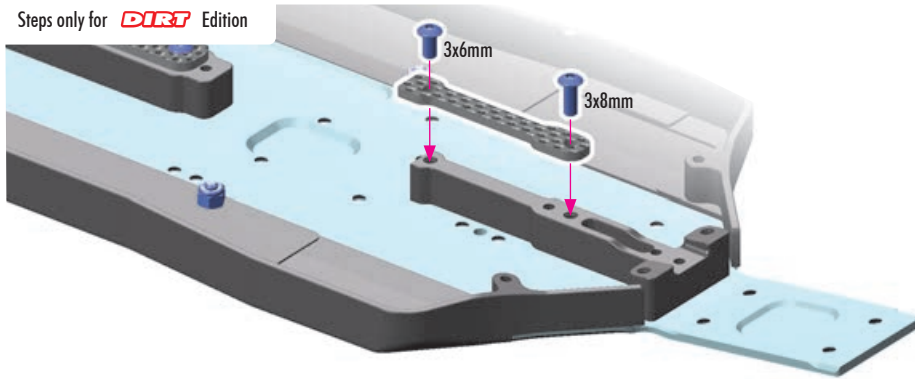

2x 902312 SH M3x12

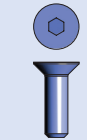

4x 903310 SFH M3x10

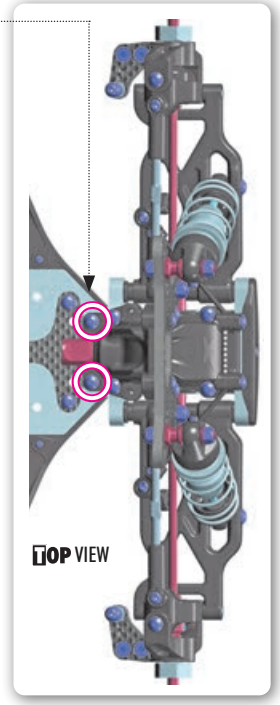
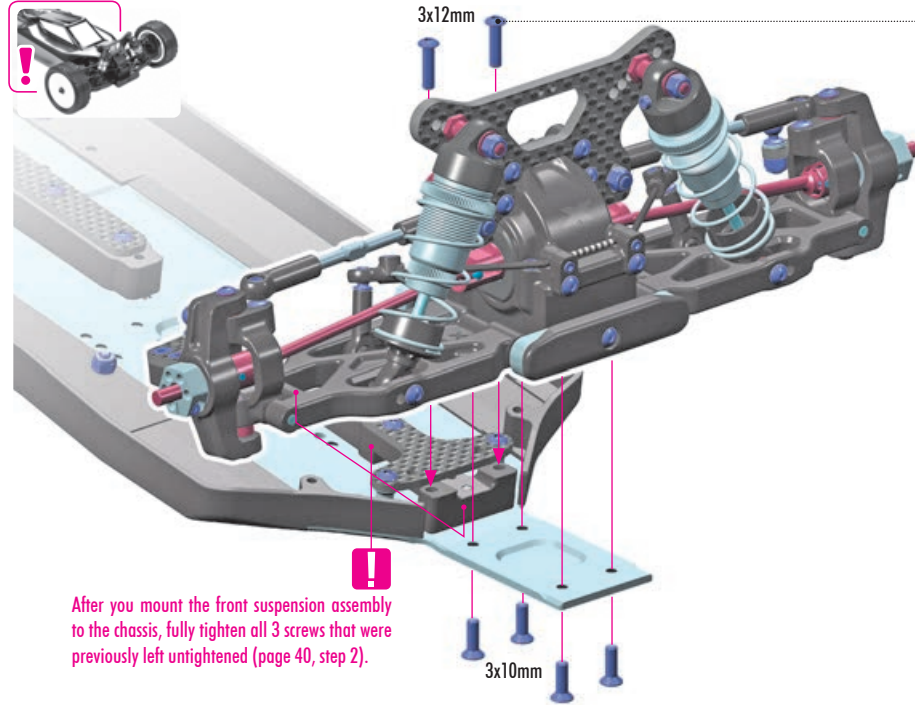

After you mount the front suspension assembly to the chassis, fully tighten all 3 screws that were previously left untightened (page 40, step 2).



2x 902318 SH M3x18

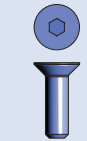

2x 903310 SFH M3x10

#366161

Choose the diameter of O-ring to best eliminate play between the battery and post without being too tight.



Select the battery mount 1/2/3/4 position to match the battery pack length.

When using the 3rd or 4th battery position, it is necessary to remove the nut.

#326181 STAINLESS STEEL BATTERY WEIGHT 35G OPTION

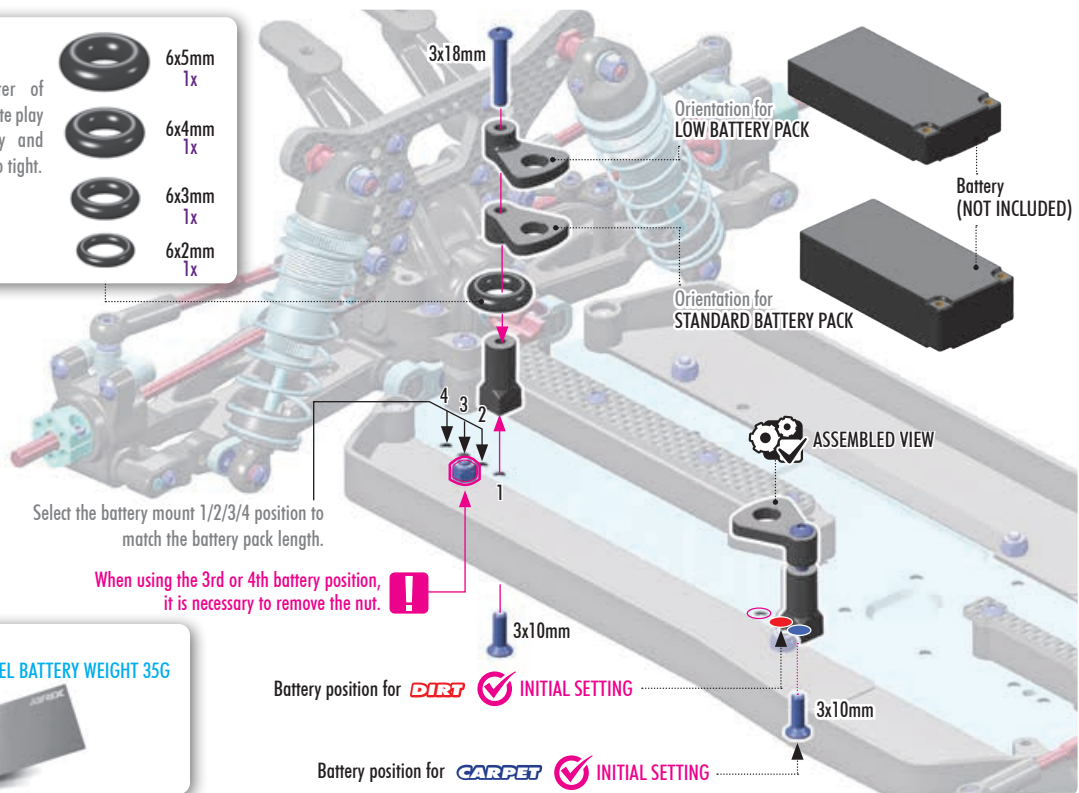



1x 970100
O 10x1.5

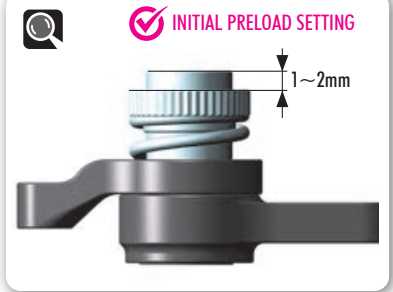
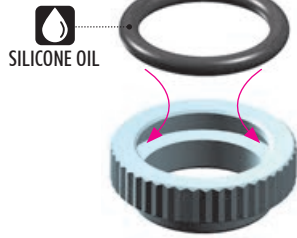

2x 902310
SH M3x10

Steps only for **CARPET** Edition

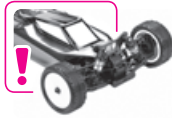
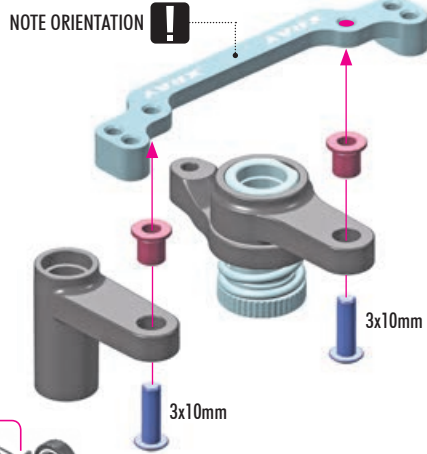

Steps only for **DIRT** Edition

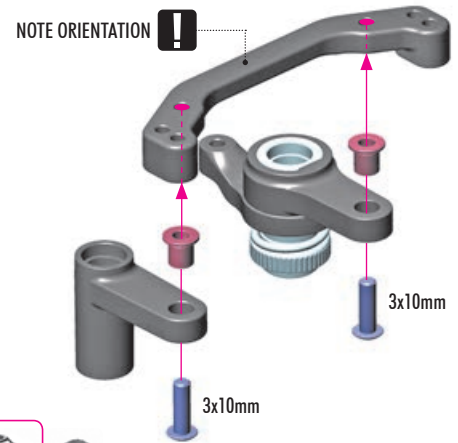

2x 303122
SHIM 3x6x1



2x 902308
SH M3x8



1x 903308
SFH M3x8



4x 940508
BB 5x8x2.5

NOTE ORIENTATION !

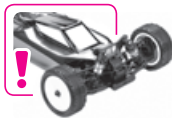
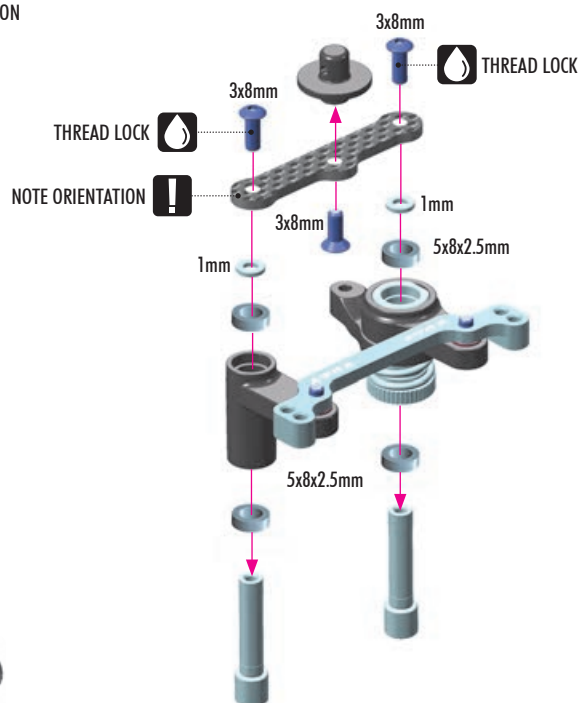

11. STEERING

CARPET

DIRT

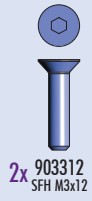

Steps only for **CARPET** Edition

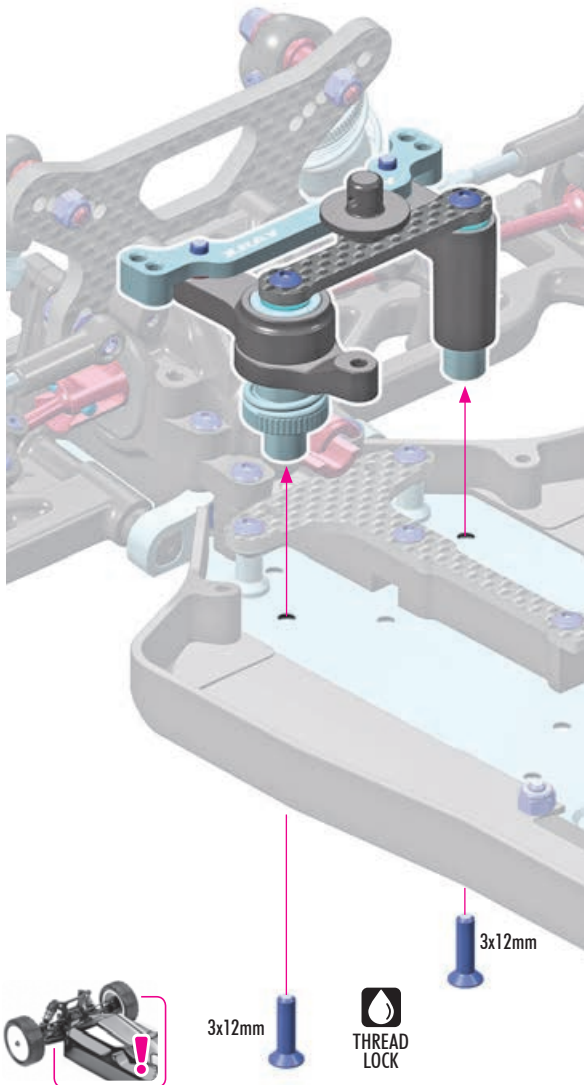

Steps only for **DIRT** Edition

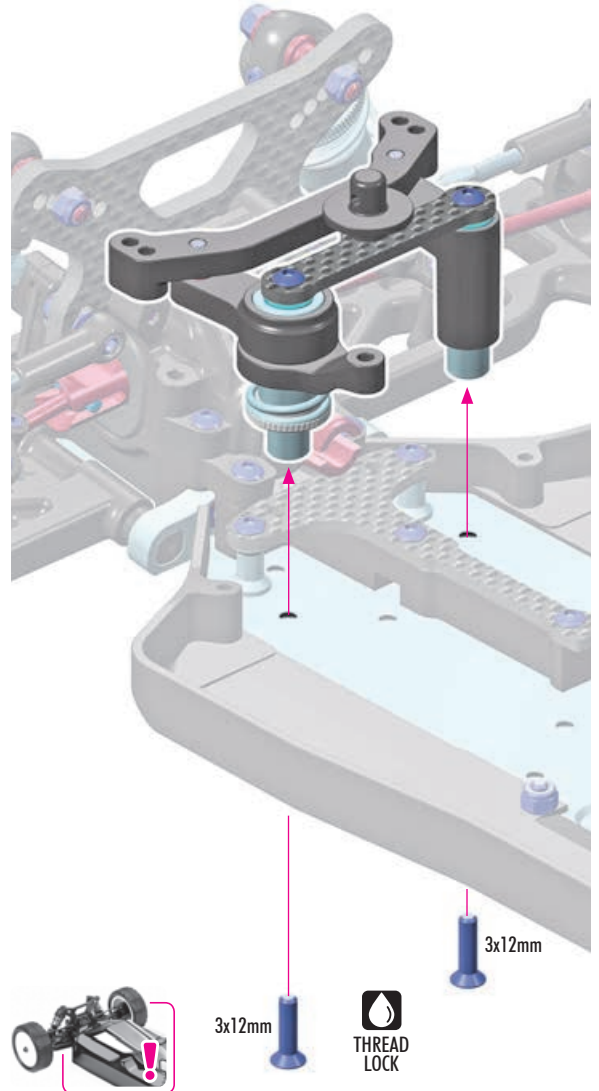

2x LEFT = RIGHT



! SLOT ORIENTATION

Thread 8mm

Ball ø5.4mm

TIP Install with HUDY Multi Tool.

LEFT THREAD

RIGHT THREAD

✓
INITIAL SETTING
21mm



✓
INITIAL SETTING
21mm



2x 303122 SHIM 3x6x1

2x LEFT = RIGHT

Steps only for CARPET Edition

Ball joint NOTE ORIENTATION

1mm

TIP Install with HUDY Multi Tool.

ASSEMBLY VIEW

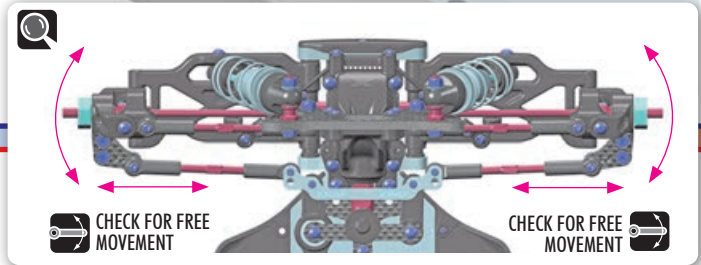
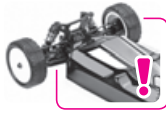

2x LEFT = RIGHT

Steps only for DIRT Edition

Ball joint NOTE ORIENTATION

TIP Install with HUDY Multi Tool.

ASSEMBLY VIEW





Please note that all central transmission components are interchangeable between the Carpet and Dirt versions, but this is only applicable when the entire central transmission assembly is replaced.

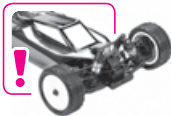
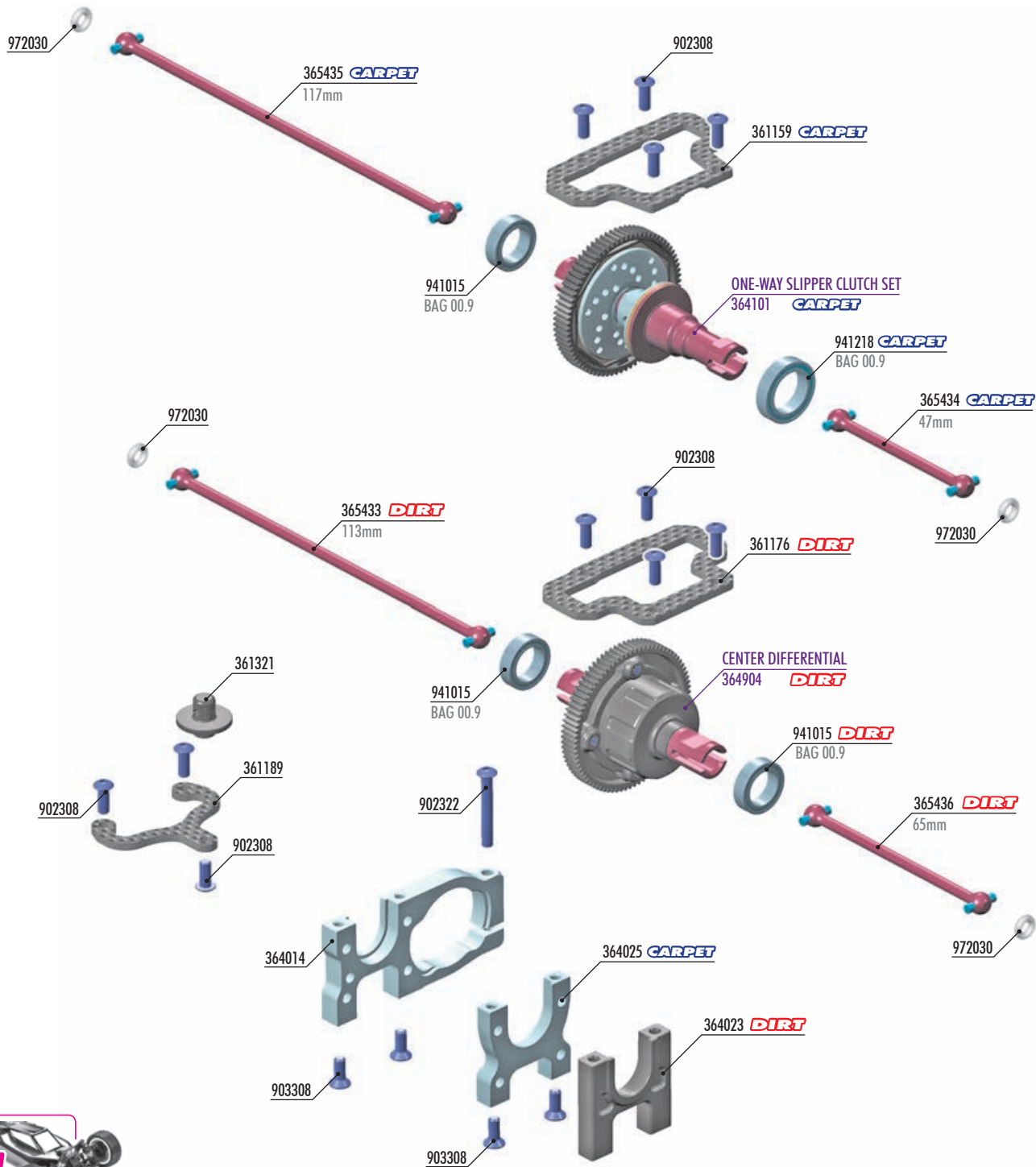

BAG

12

- 361189 CARBON REAR BODY POST HOLDER
- 361321 BODY MOUNT - SHORT + SHIMS - SET
- 364014 ALU MOTOR BULKHEAD - NARROW
- 902308 HEX SCREW SH M3x8 (10)
- 902322 HEX SCREW SH M3x22 (10)
- 903308 HEX SCREW SFH M3x8 (10)
- 941015 BALL-BEARING 10x15x4 RUBBER SEALED - OIL (2)
- 972030 SILICONE O-RING 3x2 (10)

CARPET

- 361159 CARBON CENTER UPPER DECK
- 364025 ALU CENTRAL BULKHEAD - SWISS 7075 T6
- 365434 CENTRAL DOGBONE DRIVE SHAFT 47MM - HUDY SPRING STEEL™
- 365435 CENTRAL DOGBONE DRIVE SHAFT 117MM - HUDY SPRING STEEL™
- 364101 ONE-WAY SLIPPER CLUTCH SET



DIRT

- 361176 CARBON CENTER UPPER DECK
- 364023 COMPOSITE CENTRAL BULKHEAD - LOWER
- 365433 CENTRAL DOGBONE DRIVE SHAFT 113MM - HUDY SPRING STEEL™
- 365436 CENTRAL DOGBONE DRIVE SHAFT 65MM - HUDY SPRING STEEL™
- 941218 BALL-BEARING 12x18x4 RUBBER SEALED - OIL (2)
- 364904 GEAR CENTER DIFFERENTIAL - LARGE VOLUME - SET

12. CENTRAL TRANSMISSION

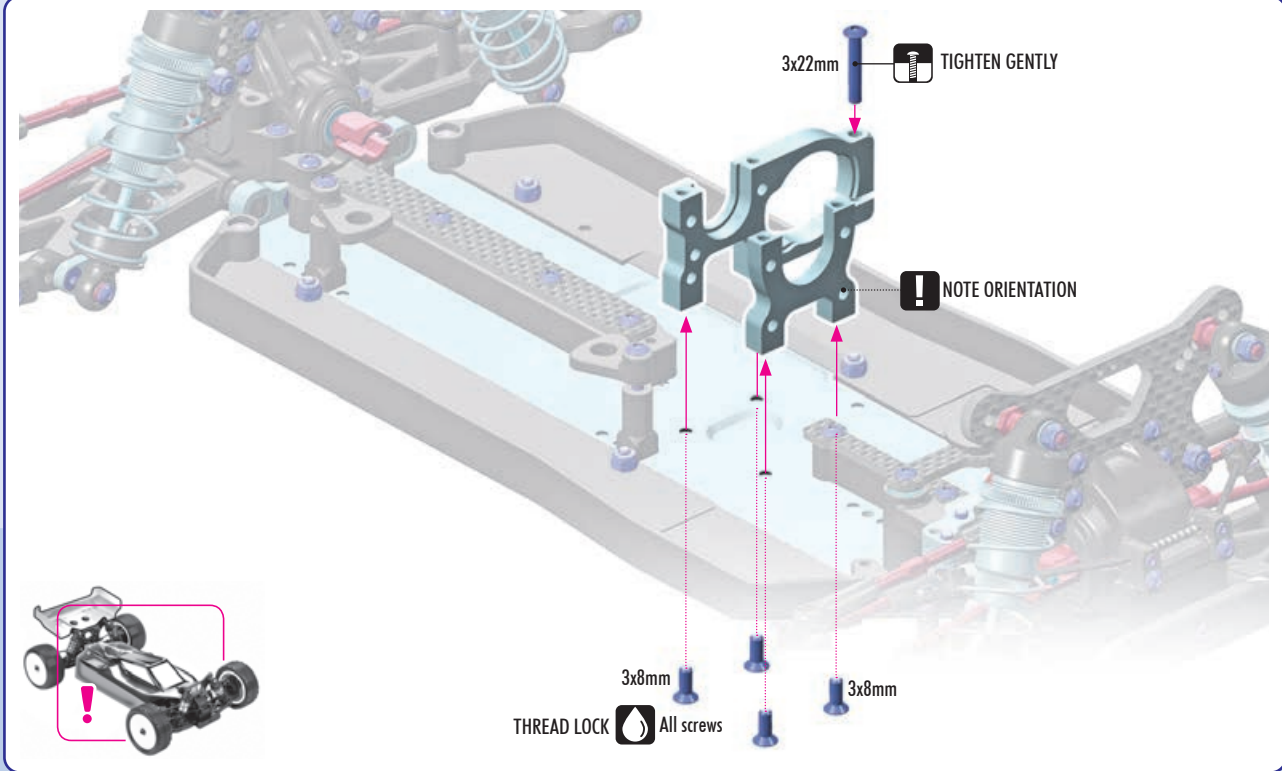
-  1x 902322 SH M3x22
-  4x 903308 SFH M3x8



-  1x 941015 BB 10x15x4
-  1x 941218 BB 12x18x4
-  2x 972030 O 3x2

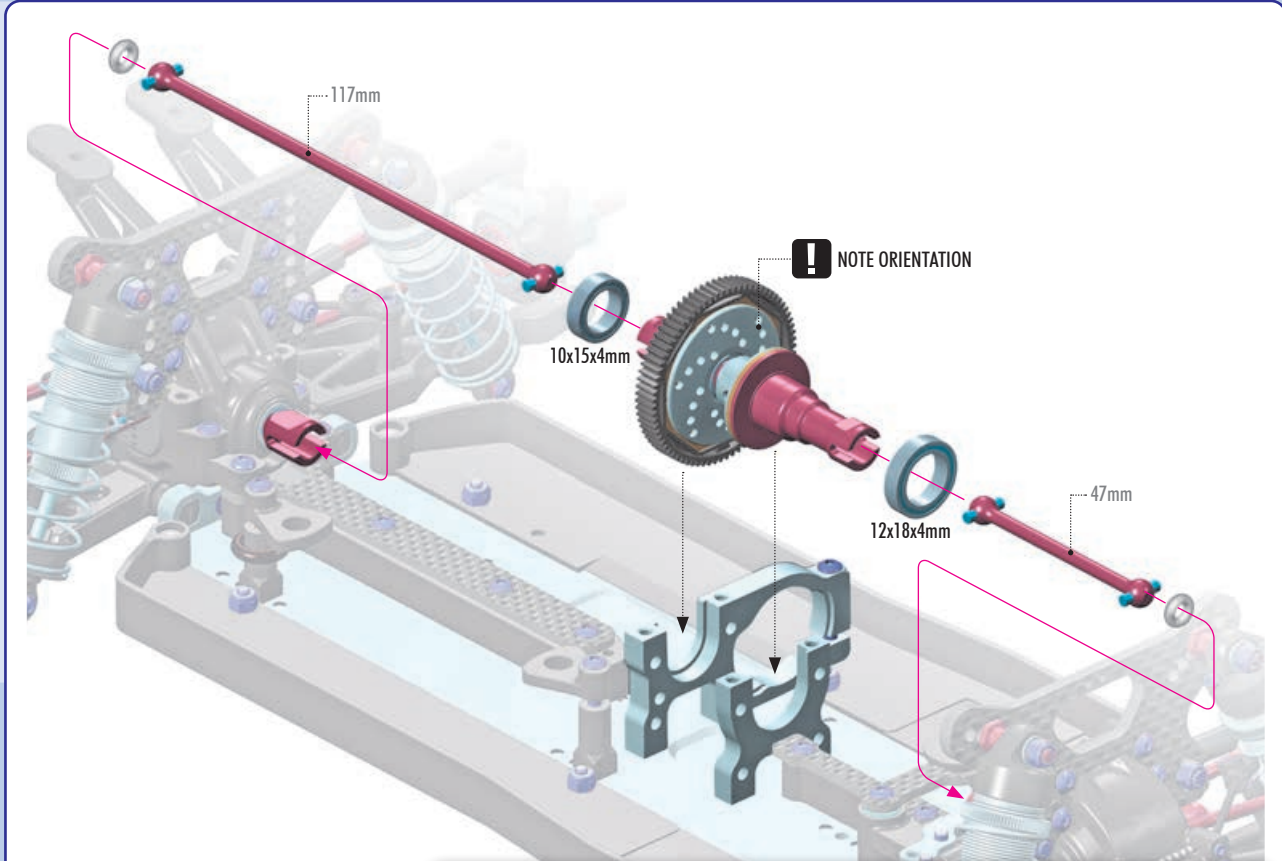

 #364102 XB4 SLIPPER ELIMINATOR - SET

 You need +



Applies for **CARPET** Edition

 #365436 CENTRAL DOGBONE DRIVE SHAFT 65mm - HUDY SPRING STEEL™

 #364024 ALU CENTRAL BULKHEAD or #364023 COMPOSITE CENTRAL BULKHEAD

 #361176 GRAPHITE CENTER UPPER DECK - V2

! VERY IMPORTANT!
It is very important that you NEVER FULLY TIGHTEN the Slipper Clutch. Overtightening the Slipper Clutch may result in breakage of the diff crown gear and pinion gear.

CENTRAL SLIPPER CLUTCH ADJUSTMENT

The Slipper Clutch can be adjusted by loosening the set-screw and then, while keeping the tool in the set-screw to prevent movement of the collar, rotating the spur gear by hand as indicated in the drawing.

To LOOSEN: Rotate the spur gear in the counterclockwise (CCW) direction.

- Smoother acceleration on power
- Easier to drive

To TIGHTEN: Rotate the spur gear in the clockwise (CW) direction.

- More forward drive
- Less forgiving

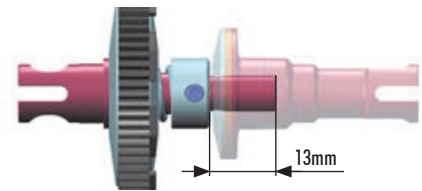

ONE-WAY SLIPPER CLUTCH ADJUSTMENT

For adjusting the front one-way slipper clutch, remove the slipper assembly from car and turn the screw inside the front outdrive using a 2.0mm wrench.

LOOSE - CCW: Greater Rear Brake Bias

- Less weight transfer to front under braking
- Smoother on landings
- Easier to drive

TIGHT - CW: More Aggressive Front Brake Bias

- Less forgiving on landings
- More difficult to drive

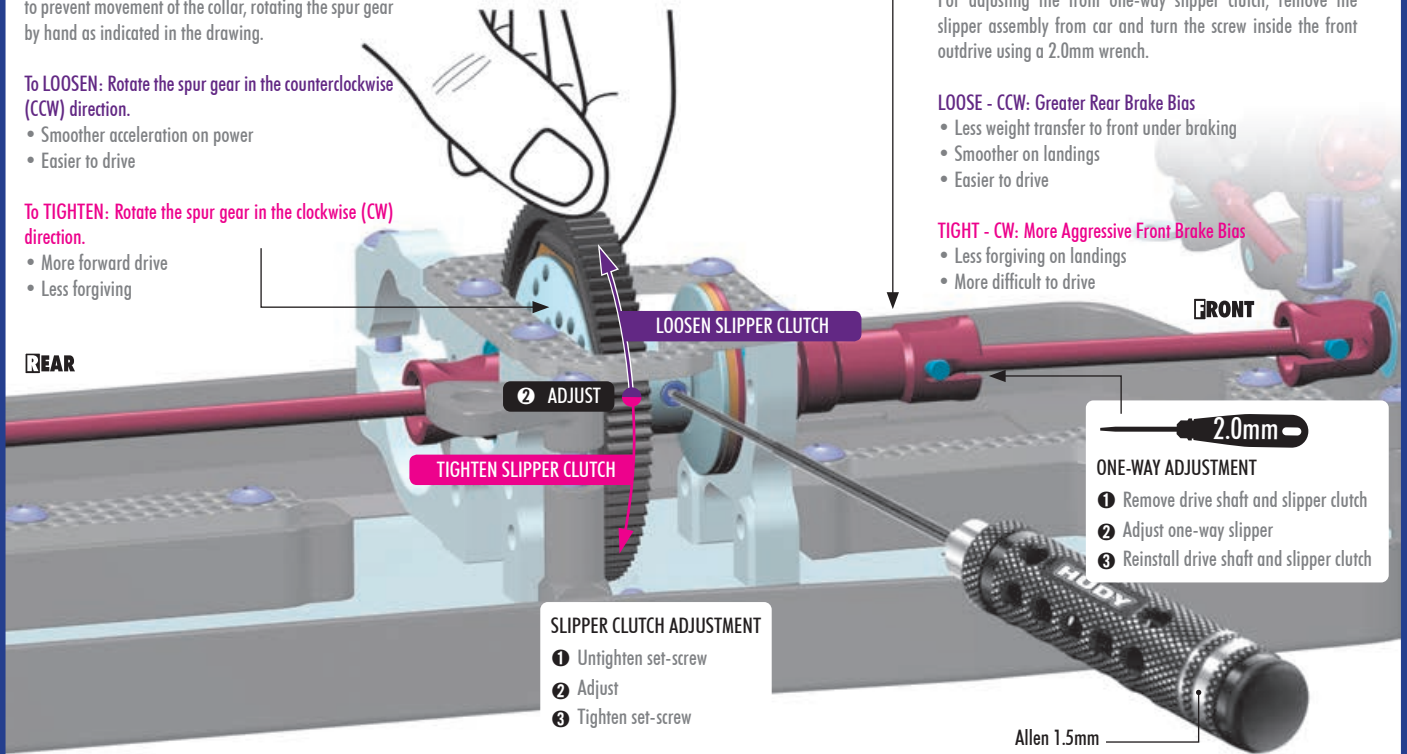

SLIPPER CLUTCH ADJUSTMENT

- 1 Untighten set-screw
- 2 Adjust
- 3 Tighten set-screw

ONE-WAY ADJUSTMENT

- 1 Remove drive shaft and slipper clutch
- 2 Adjust one-way slipper
- 3 Reinstall drive shaft and slipper clutch

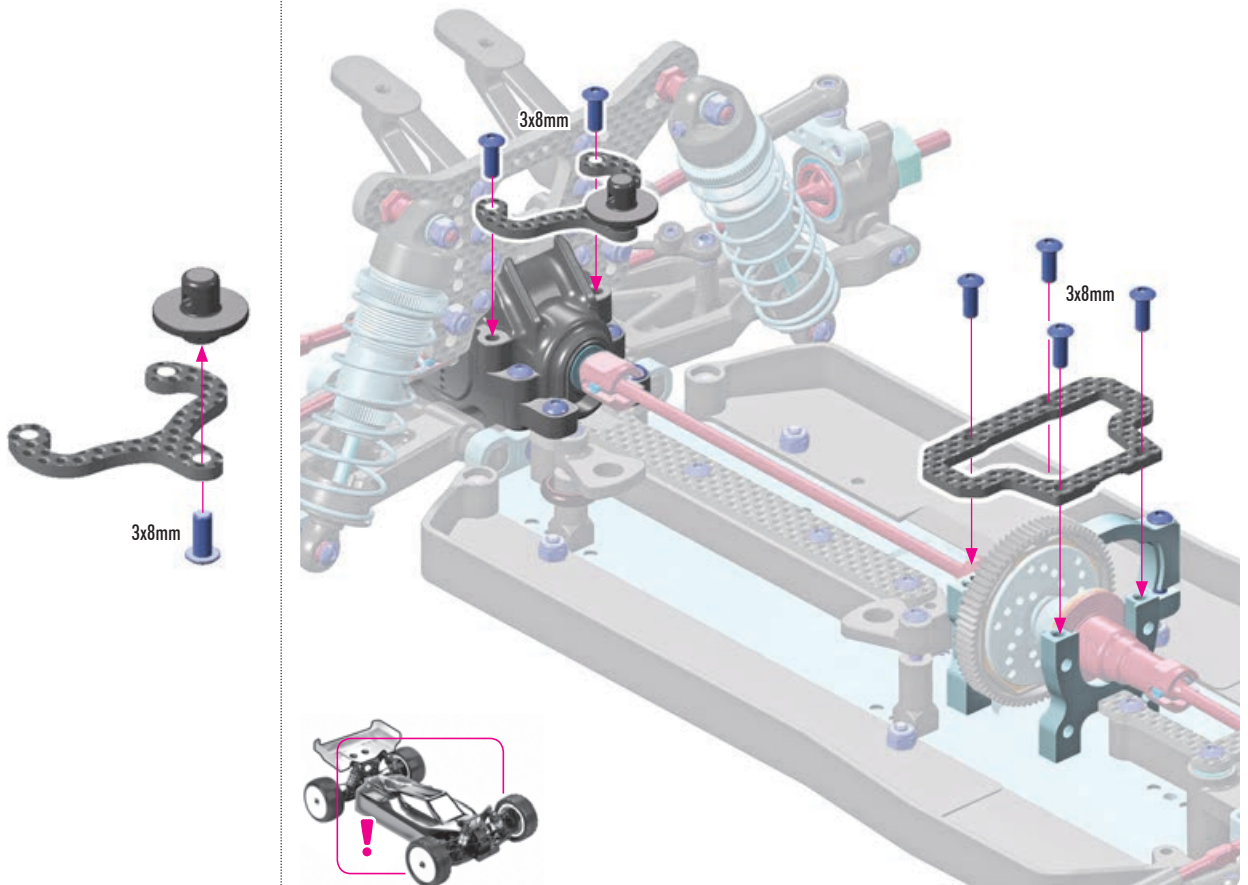
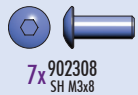

12. CENTRAL TRANSMISSION

DIRT

2x 941015
BB 10x15x4

2x 972030
O 3x2

113mm

10x15x4mm

NOTE ORIENTATION

10x15x4mm

65mm

#364102
XB4 SLIPPER ELIMINATOR - SET
OPTION

Applies for **DIRT** Edition

7x 902308
SH M3x8

3x8mm

3x8mm

3x8mm

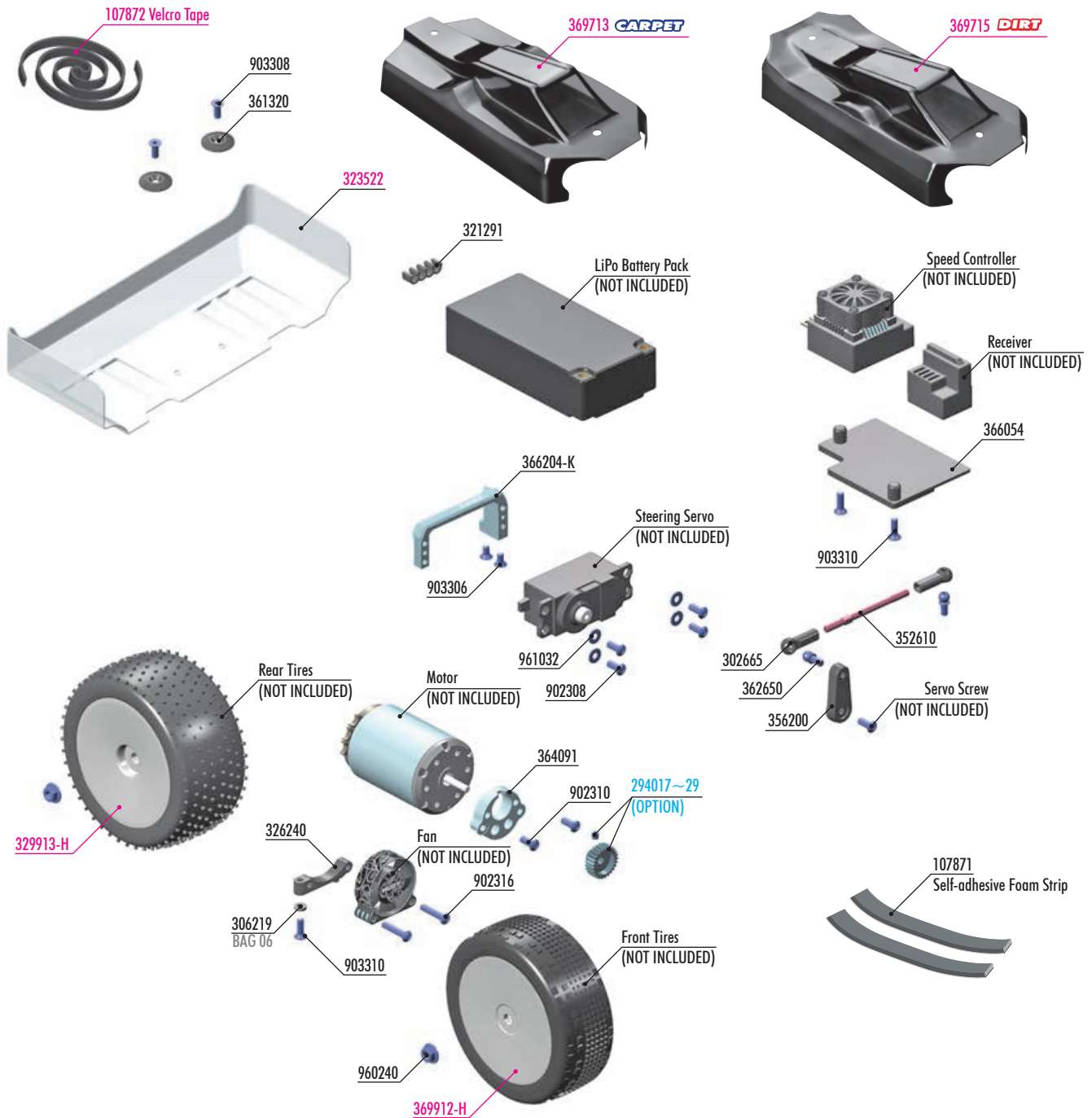

BAG

13

- 107871 HUDY SELF-ADHESIVE FOAM STRIP (2)
- 302665 COMPOSITE BALL JOINT 4.9MM - CLOSED WITH HOLE (4)
- 306219 COMPOSITE SET OF SERVO SHIMS (4)
- 321291 COMPOSITE 5-WIRES HOLDER - SET
- 326240 COMPOSITE FAN HOLDER
- 352610 ADJ. TURNBUCKLE M3 L/R 45 MM - SPRING STEEL™ (2)
- 356200 BRAKE/THROTTLE ARMS & STEERING SERVO ARMS - SET
- 361320 BODY MOUNT, BATTERY MOUNT - V2 & WING SHIM (2)
- 362650 BALL END 4.9MM WITH THREAD 6MM (2)
- 364091 ALU ECCENTRIC INSERT FOR NARROW MOTOR BULKHEAD
- 366054 COMPOSITE RADIO PLATE - SHORT
- 366204-K ALU MONOBLOCK SERVO HOLDER - SWISS 7075 T6

- 902308 HEX SCREW SH M3x8 (10)
- 902310 HEX SCREW SH M3x10 (10)
- 902316 HEX SCREW SH M3x16 (10)

- 903306 HEX SCREW SFH M3x6 (10)
- 903308 HEX SCREW SFH M3x8 (10)
- 903310 HEX SCREW SFH M3x10 (10)
- 961032 WASHER S 3.2 (10)
- 960240 NUT M4 WITH SERRATED FLANGE (10)

CARPET

369713 BODY FOR 1/10 4WD OFF-ROAD BUGGY - DELTA 4C - LIGHT

DIRT

369715 BODY FOR 1/10 4WD OFF-ROAD BUGGY - DELTA 4D - LIGHT

- 107872 VELCRO TAPE WITH DOUBLE SIDED TAPE 8x500MM
- 323522 LEXAN REAR WING - LUSH
- 329913-H REAR WHEEL AERODISK WITH 12MM HEX IFMAR - WHITE - HARD (2)
- 369912-H FRONT WHEEL AERODISK WITH 12MM HEX IFMAR - WHITE - HARD (2)



2x 902310
SH M3x10

Motor (NOT INCLUDED)

NOTE ORIENTATION

3x10mm

Pinion & Set screw (NOT INCLUDED)

Loosen the screw. 1

2 Insert motor into the bulkhead.

PINIONS (48P)		
#294017	17T	
#305918	18T	
#294019	19T	
#294020	20T	
#294021	21T	
#294022	22T	
#294023	23T	
#294024	24T	
#305925	25T	
#365726	26T	
#365727	27T	
#365728	28T	
#365729	29T	

RECOMMENDED INITIAL COMBINATIONS			
Motor	Spur	Pinion	Ratio
4.5T	81T	17T	11.91
5.5T	81T	18T	11.25
6.5T	81T	19T	10.65
7.5T	81T	20T	10.12
8.5T	81T	21T	9.64
10.5T	72T	24T	7.50
13.5T	72T	25T	7.20

GEAR RATIO Final Drive Ratio

$81 : X \times 2.5 = \text{FDR}$

(Spur) (Pinion) (IGR)

GEAR MESH

- 1 Adjust gear mesh.
- 2 Tighten the screw.
- 3 Check the gear mesh again.
- 4 Redo if necessary.

Note orientation of the motor soldering tabs to install cables as low as possible.

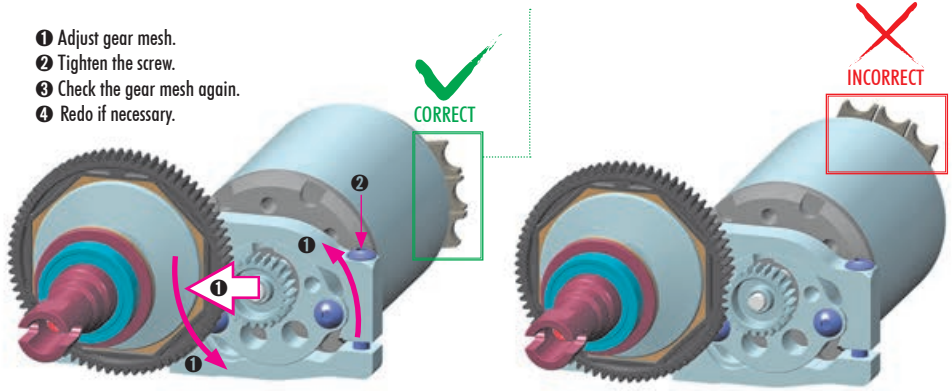

Adjust the motor so the pinion meshes with the spur gear properly. Make sure the gear mesh is not too tight.

There should be a small amount of play between the teeth of the pinion gear and the spur gear.

10
1x 306219
SHIM 3x6x2



2x 902316
SH M3x16



3x 903310
SFH M3x10

OPTION #293101 HUDY ALU RC FAN 30MM
SIDE MOUNT 2 HOLE



OPTION #293100 HUDY ALU RC FAN 30MM
BOTTOM MOUNT 2 HOLE



OPTION #293110 HUDY BRUSHLESS RC FAN 30MM
WITH EXTERNAL SOLDERING TABS



OPTION #293112 HUDY BRUSHLESS RC FAN 30MM
WITH INTERNAL SOLDERING TABS



Speed Controller
(NOT INCLUDED)

OPTION #107876
HUDY ULTRA THIN DOUBLE-
SIDED TAPE - SINGLE STRIP (5)

OPTION #107875
DOUBLE-SIDED TAPE

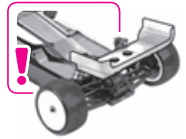
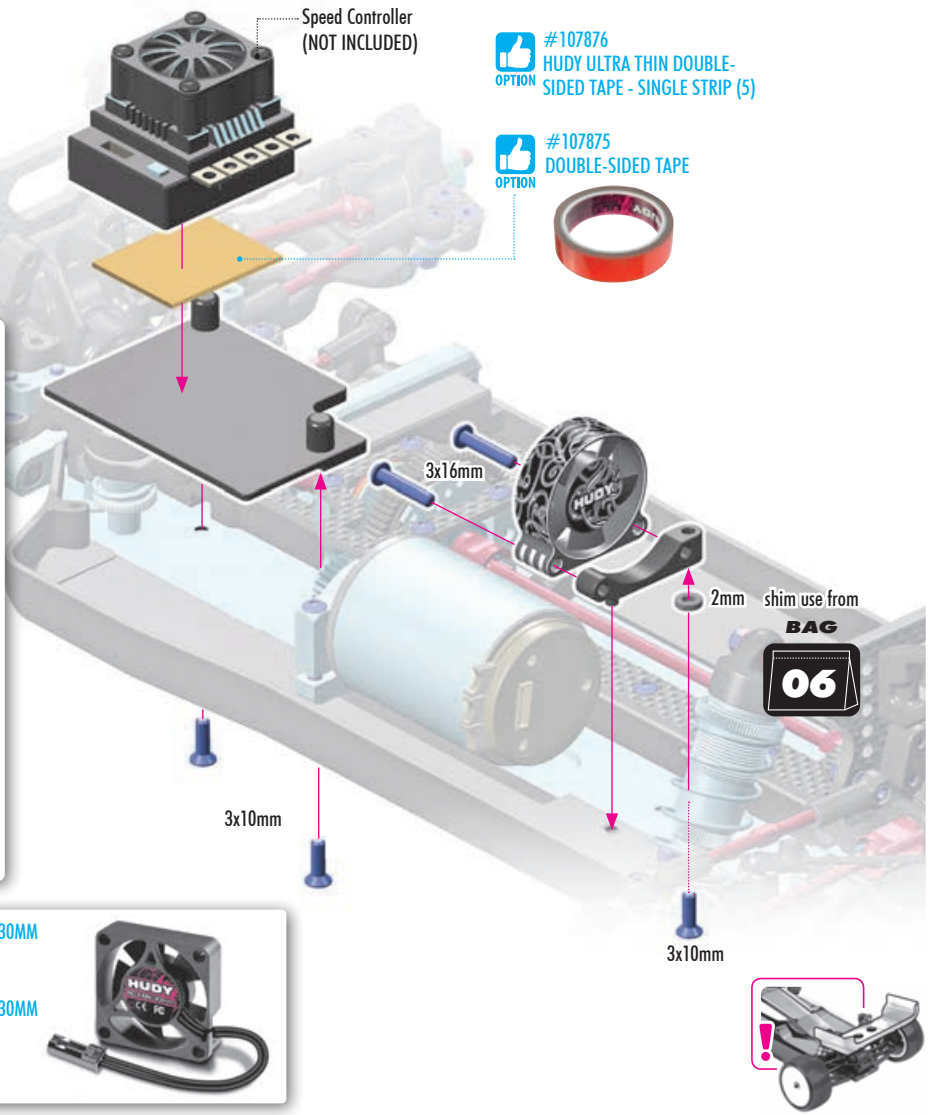

OPTION #293081
HUDY PURE TUNGSTEN WEIGHT 5g



OPTION #293082
HUDY PURE TUNGSTEN WEIGHT 10g



OPTION #293083
HUDY PURE TUNGSTEN WEIGHT 15g



Receiver
(NOT INCLUDED)

OPTION #107876
HUDY ULTRA THIN DOUBLE-
SIDED TAPE - SINGLE STRIP (5)

OPTION #107875
DOUBLE-SIDED TAPE

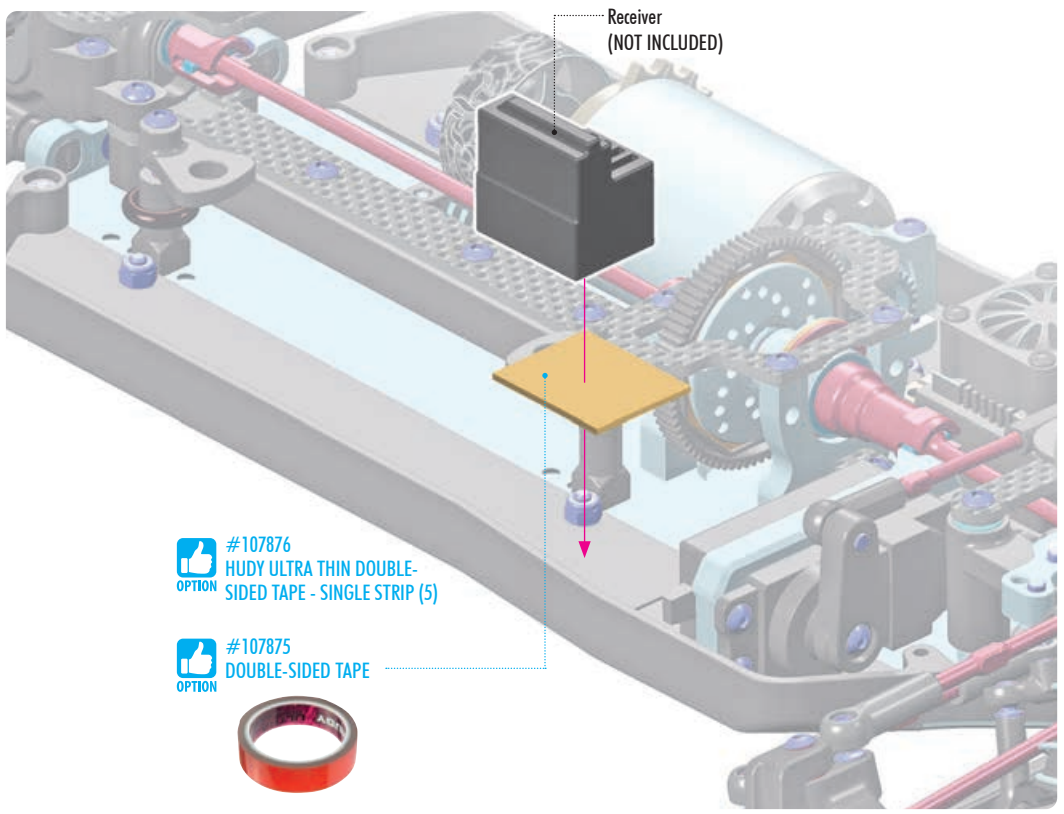

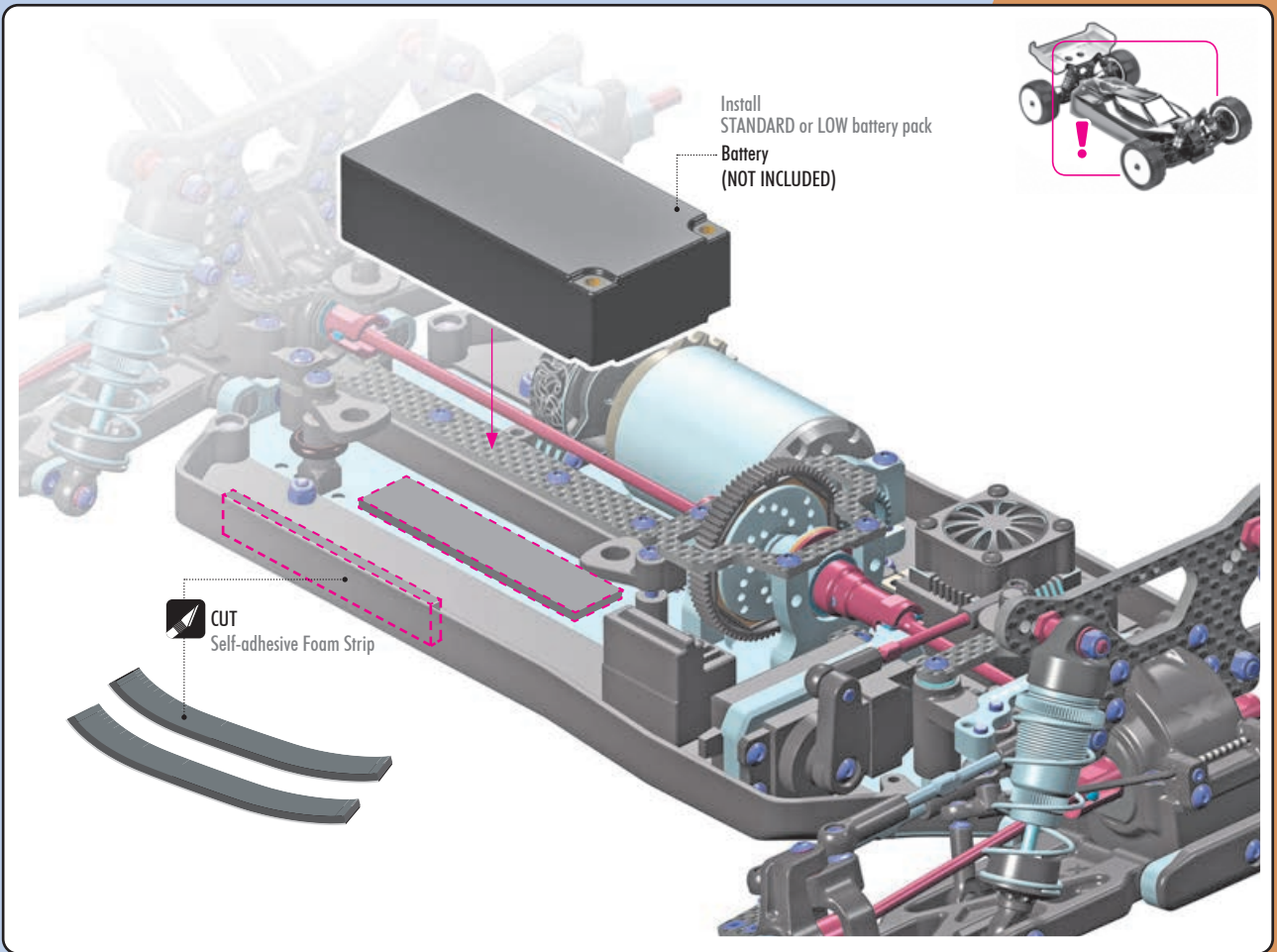

SCISSORS (HUDY #188990)
OPTION



BODY REAMER (HUDY #107602)
OPTION

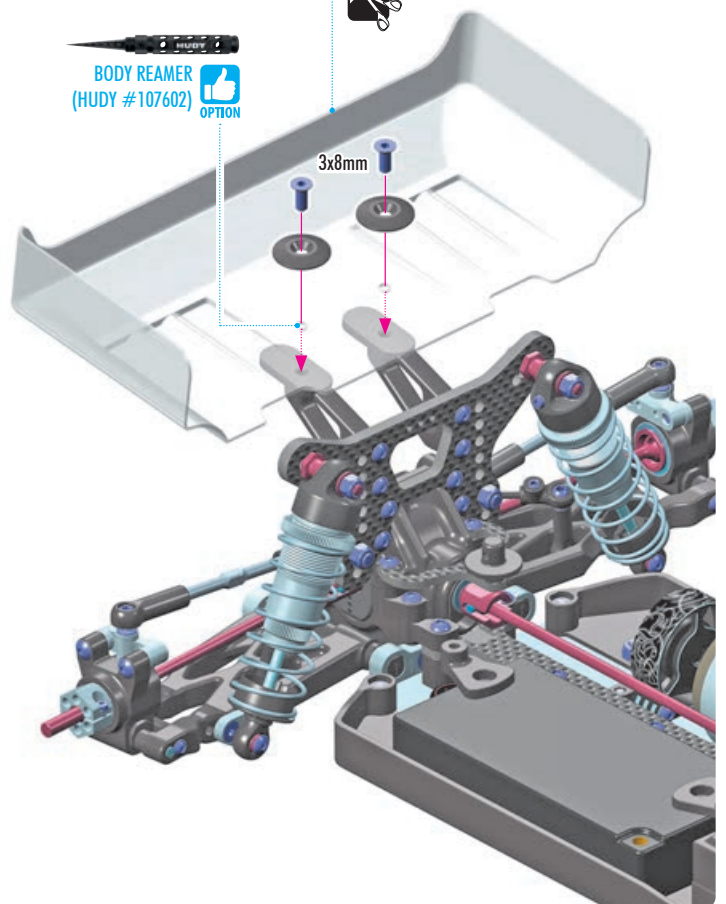

REAR WING SHIMS			
OPTION	#293561	SILVER	OPTION
	#293561-0	ORANGE	OPTION
	#293561-K	BLACK	OPTION

XRAY LEXAN REAR WINGS			
OPTION	#323510	1.0mm	OPTION
	#323511	1.5mm	OPTION
	#323513	1.0mm	RANK OPTION
	#323517	1.0mm	TEC OPTION
	#323522	Std.	LUSH INCLUDED
	#323523	Thick	LUSH OPTION
	#363510	1.0mm	OPTION
	#363511	1.5mm	OPTION
	#363512	2.0mm	OPTION

XRAY LEXAN CENTER FIN			
	#323515	1.0mm	ZAP OPTION

- 1 Before cutting and making holes on the BODY, put the unpainted body on the chassis to confirm the mounting position and location for holes and cutouts. Before cutting and making holes on the WING, put the unpainted wing on the wing holders to confirm the mounting position and location for holes and cutouts.
- 2 Before painting, wash the inside of the body with mild detergent, and then rinse and dry thoroughly.
- 3 Mask all windows.

- 4 Apply paint masks as appropriate.
- 5 Paint the body using paints formulated for polycarbonate bodies.
- 6 When the paint is dry, remove the masking.
- 7 Carefully cut out the body using appropriate scissors or cutting tools.
- 8 When you have finished cutting, peel off the external protective films.

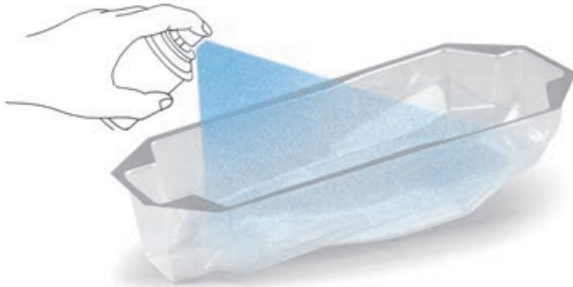

XRAY LEXAN BODY

#369712	0.75mm	DELTA 4C	OPTION
#369713	0.50mm	DELTA 4CL	INCLUDED
#369714	0.75mm	DELTA 4D	OPTION
#369715	0.50mm	DELTA 4DL	INCLUDED



#209240

HUDY BODY POST HOLE PROTECTOR VINYL STICKER 7x16x0.5mm (8)

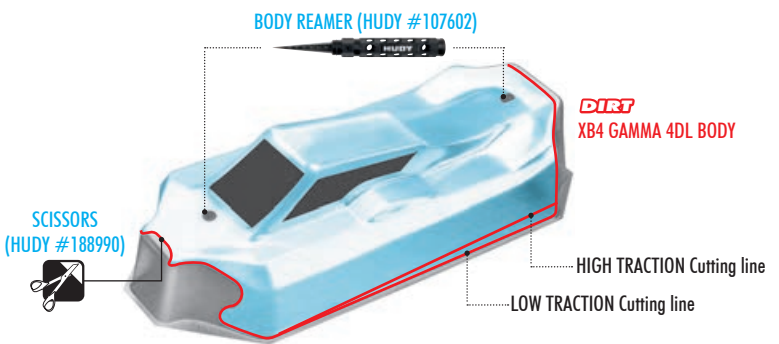
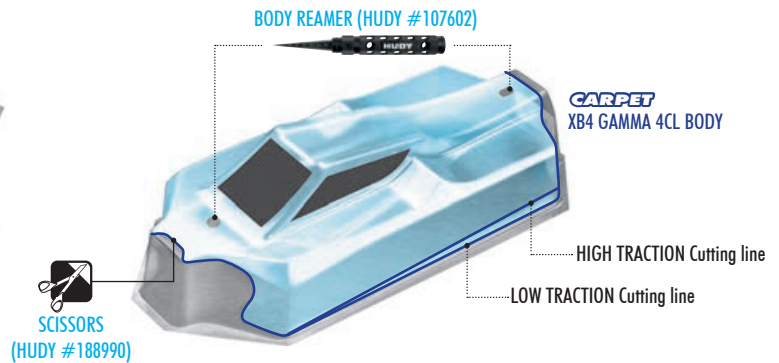

2x L=R

Double-sided Velcro™ tape is used to seal the body against the side guards.

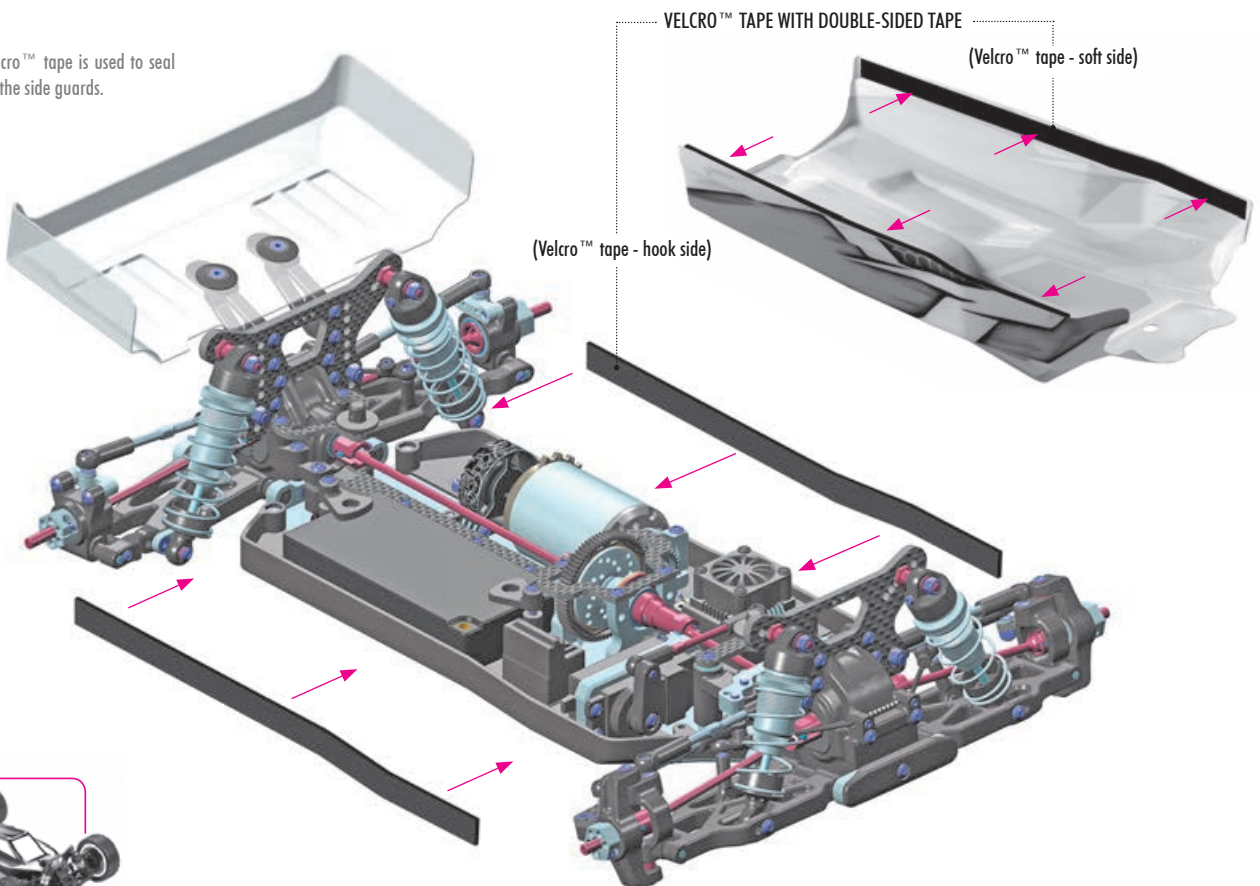

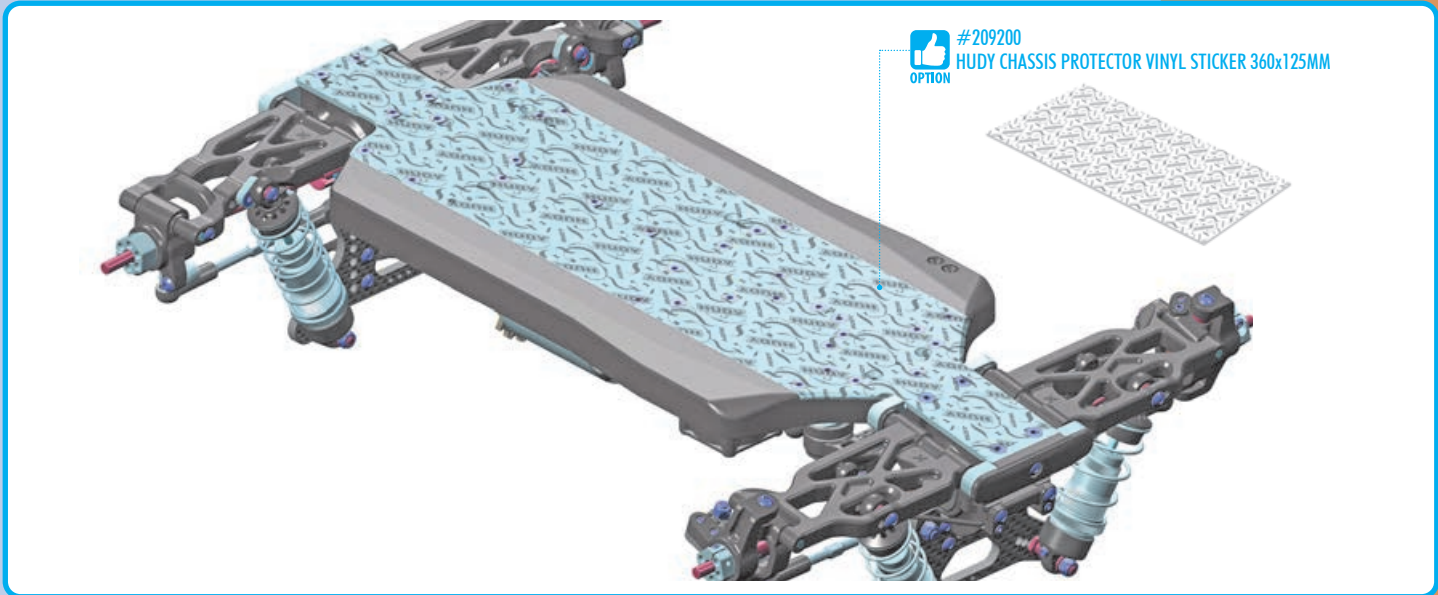

#209200
 HUDY CHASSIS PROTECTOR VINYL STICKER 360x125MM
 OPTION



4x 960240
 N M4

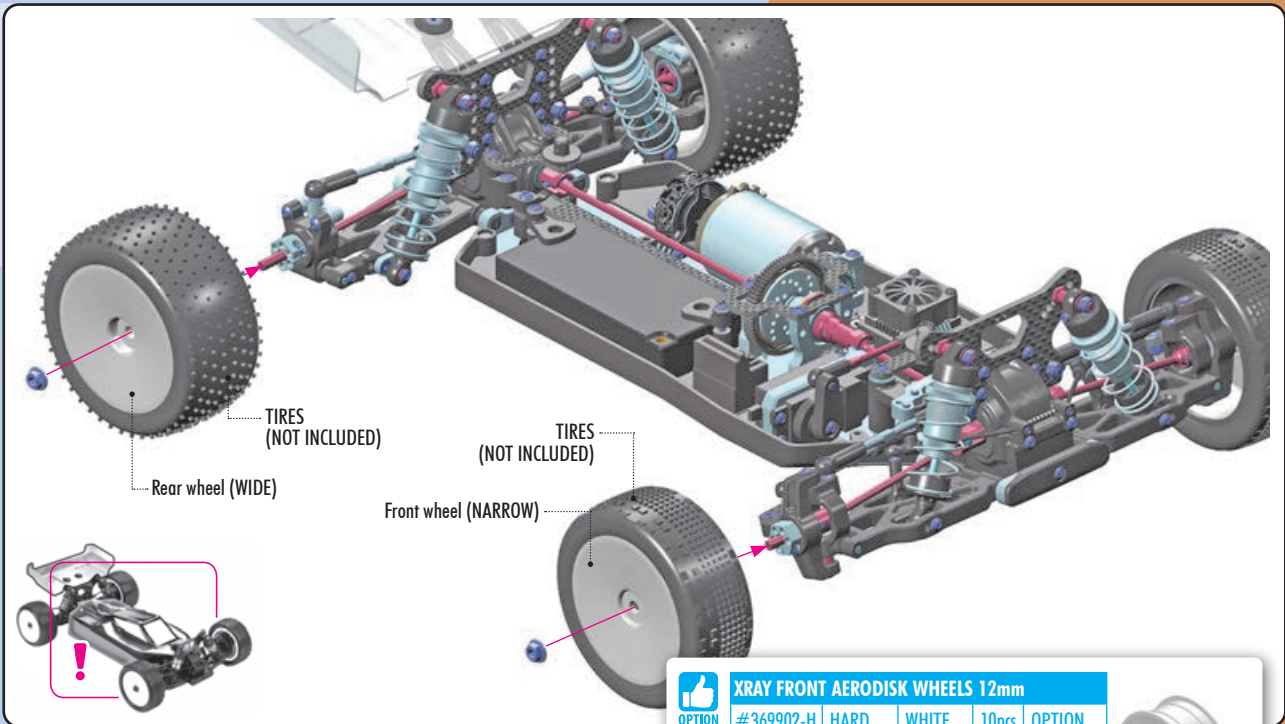

TIRES
 (NOT INCLUDED)

Rear wheel (WIDE)

TIRES
 (NOT INCLUDED)

Front wheel (NARROW)

XRAY FRONT AERODISK WHEELS 12mm

#369902-H	HARD	WHITE	10pcs	OPTION
#369902-Y	HARD	YELLOW	10pcs	OPTION
#369912-H	HARD	WHITE	2pcs	INCLUDED
#369912-Y	HARD	YELLOW	2pcs	OPTION



XRAY REAR AERODISK WHEELS 12mm

#329901-H	HARD	WHITE	10pcs	OPTION
#329901-Y	HARD	YELLOW	10pcs	OPTION
#329913-H	HARD	WHITE	2pcs	INCLUDED
#329913-Y	HARD	YELLOW	2pcs	OPTION

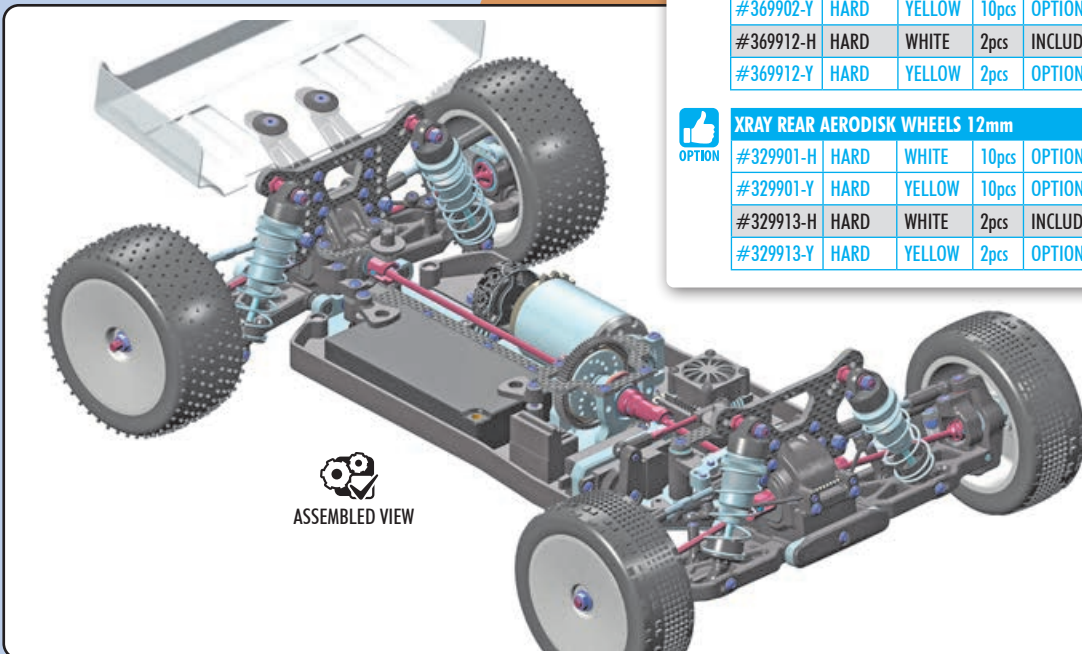

ASSEMBLED VIEW

EXCLUSIVE PROFESSIONAL

HUDY

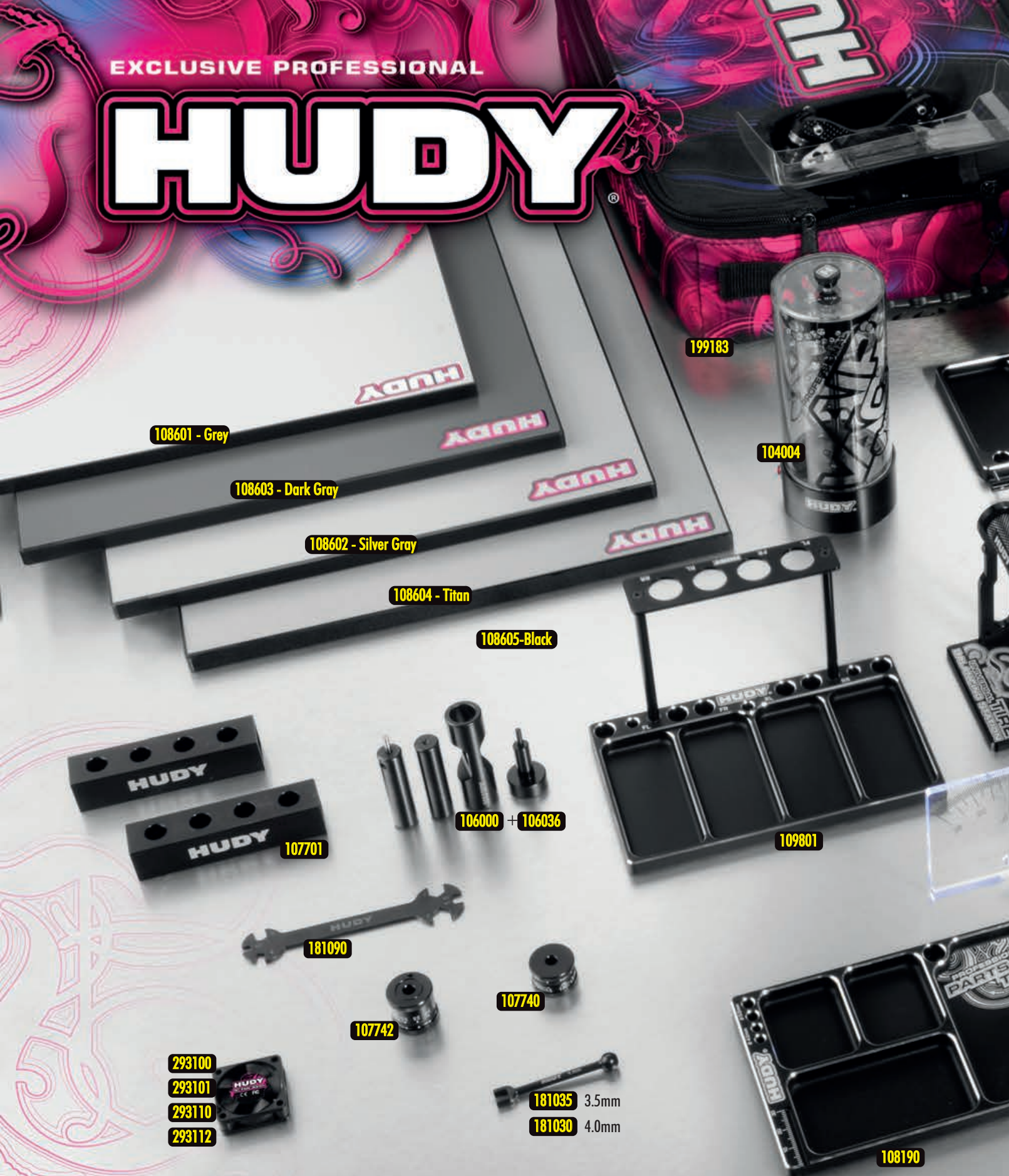

108601 - Grey

108603 - Dark Gray

108602 - Silver Gray

108604 - Titan

108605-Black

199183

104004

107701

106000 + 106036

109801

181090

107740

107742

293100

293101

293110

293112

181035 3.5mm

181030 4.0mm

108190

- 104004 HUDY AIR VAC - VACUUM PUMP - 1/10 OFF-ROAD
- 105500 HUDY UNIVERSAL TIRE BALANCING STATION
- 105520 WHEEL ADAPTER FOR 1/10 TOURING CARS - 12MM
- 106000 HUDY DRIVE PIN REPLACEMENT TOOL (FOR 3MM PINS)
- 106036 EJECTOR PIVOT PIN & ALTERNATING PIVOT 2.5MM FOR #106000
- 107090 HUDY BEARING CHECKING TOOL
- 107601 LIMITED EDITION - REAMER FOR BODY 0-9MM + COVER - SMALL
- 107701 CHASSIS DROOP GAUGE SUPPORT BLOCKS 20MM FOR 1/8 - LW(2)
- 107740 HUDY ADJUSTABLE RIDE HEIGHT GAUGE 14-20MM
- 107742 HUDY ADJUSTABLE RIDE HEIGHT GAUGE 20-30MM
- 107855 HUDY PIT LED
- 107880 CHASSIS BALANCING TOOL (2)

- 108160 HUDY 1/10 OFF-ROAD CAR STAND - V2
- 108190 HUDY ALU TRAY FOR PARTS
- 108601 FLAT SET-UP BOARD FOR 1/10 OFF-ROAD - LIGHTWEIGHT - GREY
- 108602 FLAT SET-UP BOARD FOR 1/10 OFF-ROAD - LIGHTWEIGHT - SILVER GREY
- 108603 FLAT SET-UP BOARD FOR 1/10 OFF-ROAD - LIGHTWEIGHT - DARK GREY
- 108604 FLAT SET-UP BOARD FOR 1/10 OFF-ROAD - LIGHTWEIGHT - TITAN
- 108605 FLAT SET-UP BOARD FOR 1/10 OFF-ROAD - LIGHTWEIGHT - BLACK
- 108901 HUDY SET-UP STATION FOR 1/10 OFF-ROAD CARS
- 108960 ALU NUT FOR 1/10 OFF-ROAD SET-UP SYSTEM (4)
- 109801 HUDY ALU TRAY FOR 1/10 OFF-ROAD DIFF & SHOCKS
- 109840 HUDY ALU TRAY FOR 1/10 OFF-ROAD DIFF ASSEMBLY
- 109860 HUDY ALU TRAY FOR SET-UP SYSTEM

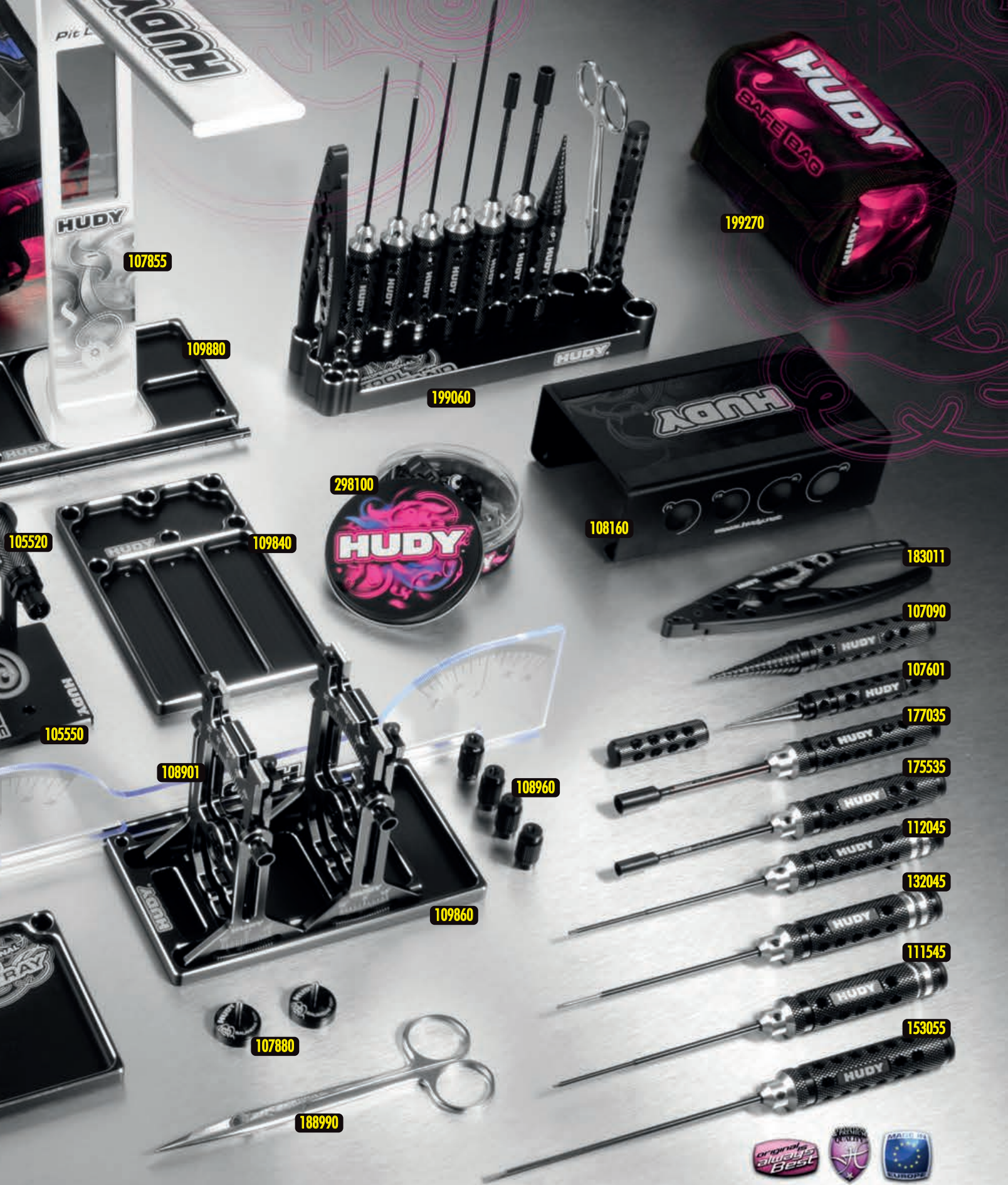

109880 HUDY ALU TRAY FOR ACCESSORIES & PIT LED
 111545 LIMITED EDITION - ALLEN WRENCH # 1.5MM
 112045 LIMITED EDITION - ALLEN WRENCH # 2.0MM
 132045 LIMITED EDITION - ALLEN WRENCH + BALL REPL. TIP # 2.0MM
 153055 LIMITED EDITION - SLOTTED SCREWDRIVER # 3.0MM - LONG
 175535 LIMITED EDITION - SOCKET DRIVER # 5.5MM
 177035 LIMITED EDITION - SOCKET DRIVER # 7.0MM
 181030 HUDY SPRING STEEL TURNBUCKLE WRENCH 3 MM
 181090 HUDY SPECIAL TOOL FOR TURNBUCKLES & NUTS
 183011 HUDY PROFESSIONAL MULTI TOOL

188990 HUDY PROFESSIONAL BODY SCISSORS
 199060 HUDY ALU TOOL STAND
 199183 HUDY CAR BAG - 1/10 OFF-ROAD
 199270 HUDY LIPO SAFETY BAG
 298100 HUDY TIN ROUND BOX 80X30MM
 293100 HUDY ALU RC FAN 30MM - BOTTOM MOUNT 2 HOLE
 293101 HUDY ALU RC FAN 30MM - SIDE MOUNT 2 HOLE
 293110 HUDY BRUSHLESS RC FAN 30MM - WITH EXTERNAL SOLDERING TABS
 293112 HUDY BRUSHLESS RC FAN 30MM - WITH INTERNAL SOLDERING TABS

For more information about tools, set-up equipment and accessories suitable for your car please visit:

www.hudy.net



www.teamxray.com

XRAY EUROPE

XRAY, K VÝSTAVISKU 6992, 91101 TRENCIN, SLOVAKIA, EUROPE
PHONE: +421-32-740 11 00, FAX: +421-32-740 11 09, info@teamxray.com

XRAY USA

RC AMERICA, 2030 Century Center Blvd #15, Irving, TX 75062, USA
PHONE: 214-744-2400, FAX: 214-744-2401, xray@rcamerica.com



/TeamXray



/TeamXray



/TeamXray



/TeamXrayRC



/XrayRacing



/XrayRacing